

bit LUBRICATOR

Mini-lubricator with high lubrication stability.

- Quantity of lubricant proportioned to air flow
- Activates at low flow rates
- Micrometric regulation of lubricant flow
- All-round oil level viewing



TECHNICAL DATA	LUB BIT 1/8"		LUB BIT 1/4"	
	1/8"		1/4"	
Threaded port	1/8"		1/4"	
Type of lubrication	Oil mist			
Bowl capacity	cm ³		26.5	
Lubricator version	Manual filling with the bowl disassembled			
Max. inlet pressure	MPa	1.3		
	bar	13		
	psi	188		
Flow rate at 6.3 bar (0.63 MPa to 91 psi) ΔP 0.5 bar (0.05 MPa to 7 psi)	Nl/min	400		
	scfm	14		
Flow rate at 6.3 bar (0.63 MPa to 91 psi) ΔP 1 bar (0.1 MPa to 14 psi)	Nl/min	710		
	scfm	25		
Max temperature at 1 MPa; 10 bar; 145 psi	°C	50		
	°F	122		
Weight	g	40		
Wall fixing screws	M4 by means of the bracket provided			
Mounting position	Vertical			
Fluid	Filtered compressed air			

COMPONENTS

- ① Technopolymer body with OT58 threaded elements
- ② Clear technopolymer bowl
- ③ Rilsan oil suction pipe
- ④ Filter
- ⑤ Technopolymer plug
- ⑥ Oil flow adjustment regulation needle made of OT58 brass
- ⑦ Clear technopolymer cover
- ⑧ NBR Venturi diaphragm
- ⑨ NBR gaskets

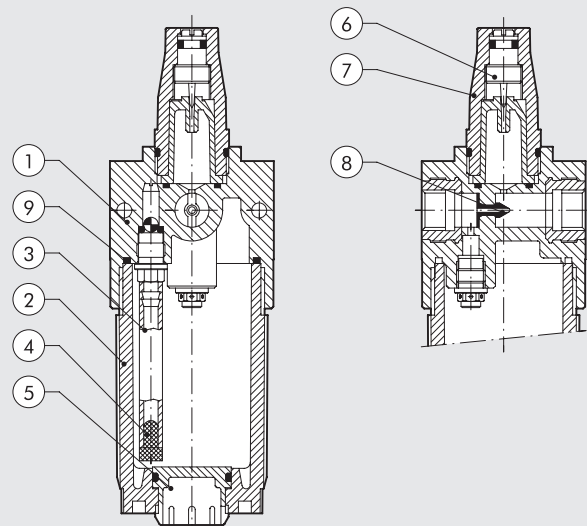

GENERAL RULES - USE AND MAINTENANCE

Use a no. 3 compass spanner to unscrew the bowl.

- Fit the lubricator as close as possible to the point of use
- Fill the bowl with oil before pressurizing the system
- Do not use cleaning oil, brake fluid or solvents in general
- For correct lubrication, set the drip rate to approximately 1 drop every 300-600 NI via the adjusting screw.
- Recommended lubricants:
ISO and UNI FD22
E.g. Energol HLP 22 (BP) – Spinesso 22 (Esso)
- Mobil DTE 22 (Mobil) – Tellus Oil 22 (Shell).

REGULATING LUBRICATION

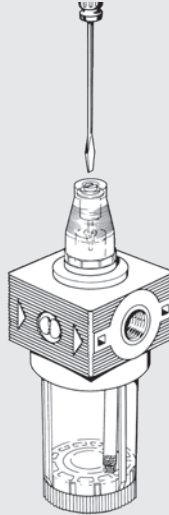

FILLING THE BOWL WITH OIL

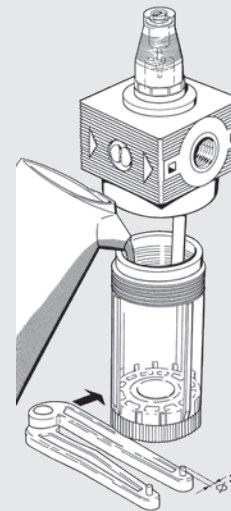

FLOW CHARTS

LUB

$\Delta P = (P_m - P_v)$

psi kPa bar

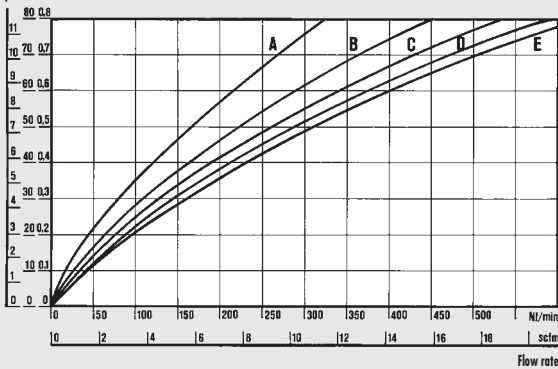

LUB 1/8-1/4

Pm

psi MPa bar

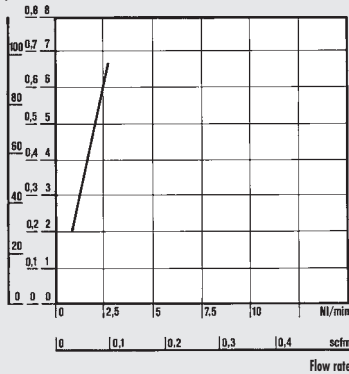

MINIMUM OPERATION FLOW CHARTS

Minimum flow tests were performed in compliance with ISO/DP 6301/2.



Department of Mechanics

Turin Polytechnic

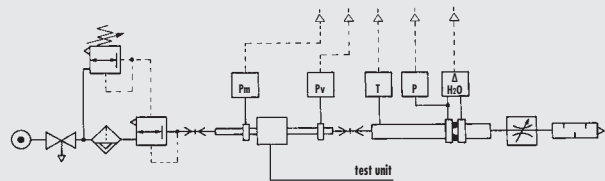

• Flow tests carried out at the Department of Mechanics, Turin Polytechnic, using the computerized test bench following CETOP RP50R recommendations (ISO DIS 6358-2-approved) with ISO 5167 diaphragm gauge.

- (A) = 2 bar - 0.2 MPa - 29 psi
- (B) = 4 bar - 0.4 MPa - 58 psi
- (C) = 6 bar - 0.6 MPa - 87 psi
- (D) = 8 bar - 0.8 MPa - 116 psi
- (E) = 10 bar - 1 MPa - 145 psi

DIMENSIONS

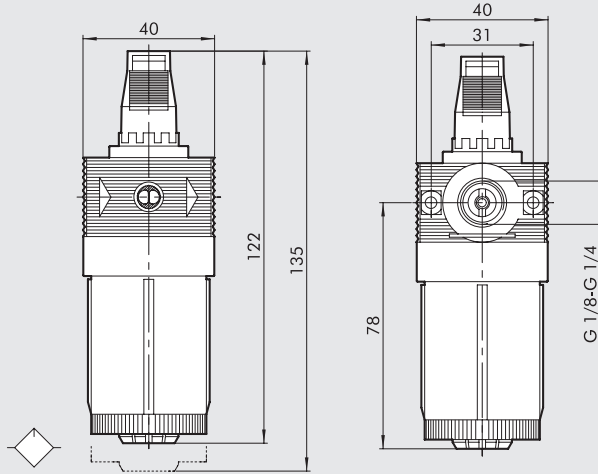

ORDERING CODES

Code	Description
5103001	LUB BIT 1/8
5203001	LUB BIT 1/4

NOTES

bit ACCESSORIES

ACCESSORIES FOR STANDARD bit AND SERIES F bit FOR WATER

PRESSURE GAUGE

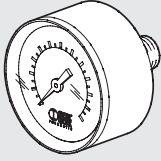

Code	Description
9700102 *	M 40 1/8 04
9700101 *	M 40 1/8 012

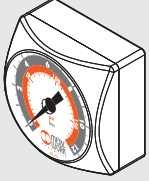

9700109 *	M 40x40 1/8 04
9700110 *	M 40x40 1/8 012

* Cannot be used with water

DOME DISASSEMBLY SPANNER

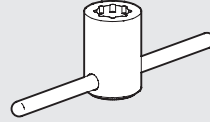

Code	Description
9220701	Cover LUB spanner

R/FR FIXING BRACKET

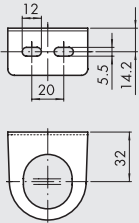

Code	Description
9200701	SF100 - BIT - ND 1/4 - SY1

COVER DISASSEMBLY SPANNER

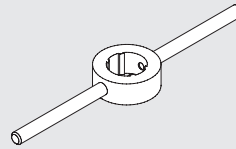

Code	Description
9170401	CS CS BIT

ASSEMBLY PLATE (PAIR)

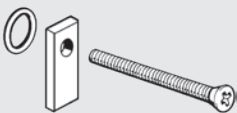

Code	Description
9170201	PAB 1/8 - 1/4 BIT

REDUCER PLUG DISASSEMBLY SPANNER

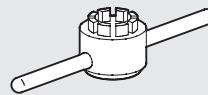

Code	Description
9170501	CS OTR BIT

WALL MOUNTING BRACKET (PAIR)

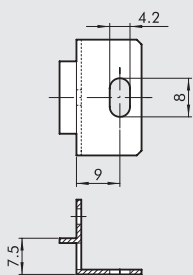

Code	Description
9170301	SFB 1/8 - 1/4 BIT

BOWL DISASSEMBLY SPANNER

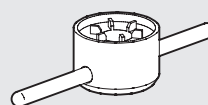

Code	Description
9170601	CS TF - TL BIT - SY1

bit SPARE PARTS



SPARE PARTS FOR STANDARD bit

UPPER COVER FOR MR

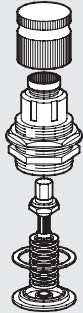

Code	Description
9250805	Spares CS 1/8 1/4 BIT 02
9250806	Spares CS 1/8 1/4 BIT 04
9250807	Spares CS 1/8 1/4 BIT 08
9250808	Spares CS 1/8 1/4 BIT 012

FILTER AND FILTER-REGULATOR BOWL

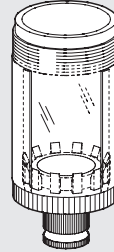

Code	Description
9255001	Spares TF 1/8 1/4 BIT RMSA
9255101	Spares TF 1/8 1/4 BIT SAC

UPPER COVER FOR MR FC

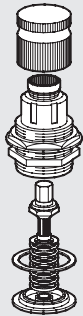

Code	Description
9250817	Spares CS FC 1/8 1/4 BIT 02
9250818	Spares CS FC 1/8 1/4 BIT 04

AUTOMATIC DRAIN (SAC)



Code	Description
9000803	Spares SAC automatic drain

UPPER COVER FOR MRA

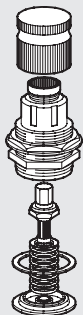

Code	Description
9250809	Spares CSA 1/8 - 1/4 BIT 02
9250814	Spares CSA 1/8 - 1/4 BIT 04
9250815	Spares CSA 1/8 - 1/4 BIT 08
9250816	Spares CSA 1/8 - 1/4 BIT 012

LUBRICATOR BOWL

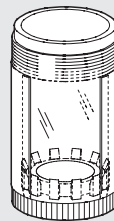

Code	Description
9251402	Spares TL 1/8 1/4 BIT

COMPLETE POPPET FOR MR AND MRA

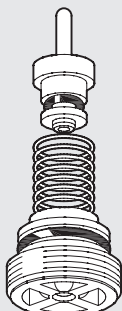

Code	Description
9250705	Spares poppet for MR
9250706	Spares poppet for MR-SR (rapid drain)
9250708	Spares poppet for MRA

FILTER ELEMENT

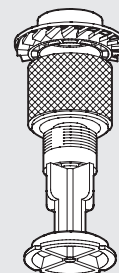

Code	Description
9251708	Spares FP 1/8-1/4 BIT 5 (yellow)
9251709	Spares FP 1/8-1/4 BIT 20 (white)
9251710	Spares FP 1/8-1/4 BIT 50 (blue)

FILTER CARTRIDGE

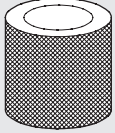

Code	Description
9251808	Spares filter cartridge BIT 5 (yellow)
9251809	Spares filter cartridge BIT 20 (white)
9251810	Spares filter cartridge BIT 50 (blue)

DEPURATOR FILTER ELEMENT

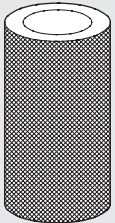

Code	Description
9251712	Spares FP DEP. 1/8 1/4 BIT

COMPLETE POPPET FOR FR



Code	Description
9250905	Spares OTFR 1/8 1/4 BIT 5 (yellow)
9250906	Spares OTFR 1/8 1/4 BIT 20 (white)
9250907	Spares OTFR 1/8 1/4 BIT 50 (blue)

TRANSPARENT LUBRICATOR COVER

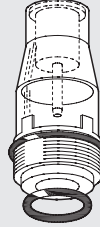

Code	Description
9251302	Spares CVL 100-200-300-400 BIT

SPRING FOR MR, FR

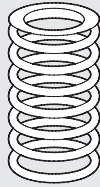

Code	Description
9250610	Spares MO 02 BIT
9250611	Spares MO 04 BIT
9250612	Spares MO 08 BIT
9250613	Spares MO 012 BIT

NOTES

SPARE PARTS FOR SERIES F bit FOR WATER

FILTER ELEMENT



Code	Description
9251709	Spares FP 1/8-1/4 BIT 20 (white)

SPRING FOR REG F, FR F



Code	Description
9250610	Spares MO 02 BIT
9250611	Spares MO 04 BIT
9250612	Spares MO 08 BIT
9250613	Spares MO 012 BIT

FILTER CARTRIDGE

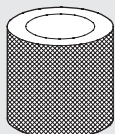

Code	Description
9251809	Spares filter cartridge BIT 20 (white)

NOTES