

Adapter-Plates AP-G

Standard dimensions 130 × 130 mm

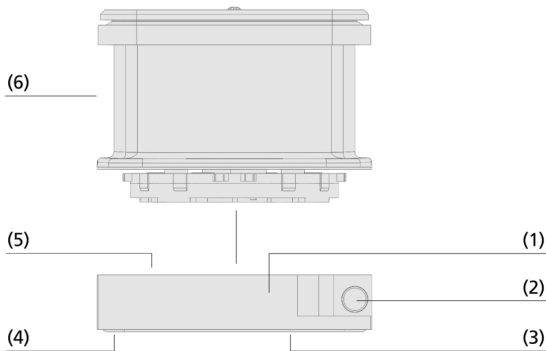

Adapter-Plates AP-G



System design Adapter-Plates AP-G

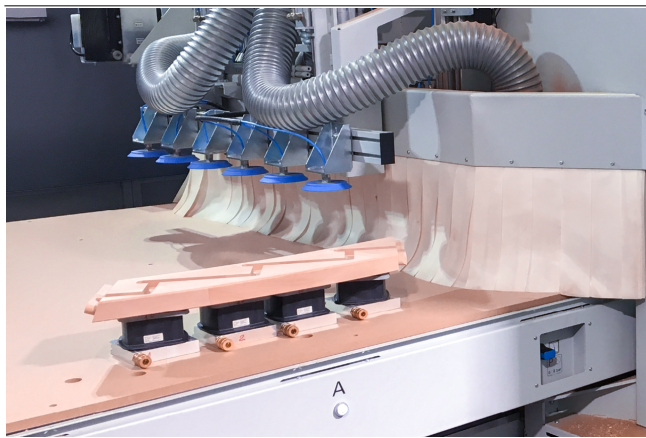

Adapter-Plates AP-G with vacuum block VCBL-B when clamping a wooden workpiece

Suitability for industry specific applications

Applications

- Adapter-Plate for using vacuum blocks VCBL-B on nesting machine tables
- The Adapter-Plate is supplied with vacuum via a hose that is connected to the template connection of the machine
- Vacuum blocks VCBL-B are placed into the suction cup mount of the Adapter-Plate at any orientation in 15° steps to orient the suction area as desired
- The vacuum blocks are available in three different heights (29, 48 and 74 mm) and four different suction areas

Design

- Robust main body (1) made of aluminum
- Push button (2) for manual blow-off of the Adapter-Plate during positioning
- Special friction pad on the bottom (3)
- Replaceable foam rubber seal (4) for applying suction to the MDF sheet
- Suction cup mount (5) matches vacuum blocks VCBL-B
- Vacuum block VCBL-B (6) are available as accessories

Product highlights

- Modular system of Adapter-Plate and suction cups offers maximum flexibility with short set-up times
- Vacuum blocks of different heights allow several working heights and, depending on the machine, also 5-axis machining
- Friction pad milled to size on the underside optimized for smooth surfaces
- Push-button for manual ventilation of the underside allows quick positioning without switching off the vacuum
- Unused vacuum blocks VCBL-B can remain on the machine table thanks to the touch valve

Designation code Adapter-Plates AP-G

Adapter-Plates AP-G

Standard dimensions 130 × 130 mm

AP-G	–	145x130x26
1		2

1 – Abbreviated designation

Code	Type
AP-G	Adapter-Plate for nesting tables, flat table systems

2 – Dimensions

Code	LxWxHeight in mm
145x130x26	145x130x26

The adapter plate AP-G is delivered assembled. The product consists of:













- Main body made of aluminum
- Friction plate bottom

Available accessories: vacuum block, push-in fitting union, screw plug with collar, push-in nipple, compressed air coupling

Ordering data Adapter-Plates AP-G

Type	Part no.
AP-G-145x130x26	10.01.12.03876 

Ordering data Accessories Adapter-Plates AP-G

Type	Part no.
Vacuum block	VCBL-B 140x130x29 TV 10.01.12.03165 
Vacuum block	VCBL-B 125x75x29 TV 10.01.12.03166 
Vacuum block	VCBL-B 120x50x29 TV 10.01.12.03167 
Vacuum block	VCBL-B 130x30x29 TV 10.01.12.03168 
Vacuum block	VCBL-B 140x130x48 TV 10.01.12.03169 
Vacuum block	VCBL-B 125x75x48 TV 10.01.12.03170 
Vacuum block	VCBL-B 120x50x48 TV 10.01.12.03171 
Vacuum block	VCBL-B 130x30x48 TV 10.01.12.03172 
Vacuum block	VCBL-B 140x130x74 TV 10.01.12.03173 
Vacuum block	VCBL-B 125x75x74 TV 10.01.12.03174 
Vacuum block	VCBL-B 120x50x74 TV 10.01.12.03175 
Vacuum block	VCBL-B 130x30x74 TV 10.01.12.03176 

Type	Part no.
Plug union, elbow	STV-W G1/4-AG 4 10.08.02.00157
Plug union, elbow	STV-W G1/4-AG 6 10.08.02.00159
Plug union, elbow	STV-W G1/4-AG 8 10.08.02.00161
Plug union, elbow	STV-W G1/4-AG 12 10.08.02.00162
Plug union, straight	STV-GE G1/4-AG 10 10.08.02.00251
Sealing screw with collar	VRS-SB G1/4-AG ISKT O-Ring 10.08.06.00044

Type	Part no.
Plug-in nipple	EINS-NIP G1/4-IG 7.2 MS 10.01.12.04712

Type	Part no.
Pneumatic coupling	DRUC-KUPP D27 G1/4-AG NW7.2 10.01.12.04713

Adapter-Plates AP-G

Standard dimensions 130 × 130 mm

Design data Adapter-Plates AP-G

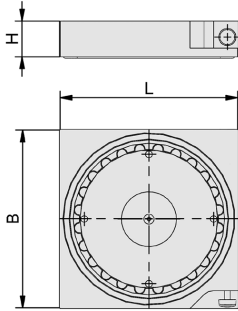

AP-G

Design data Adapter-Plates AP-G

Type	B [mm]	H [mm]	L [mm]
AP-G-145x130x26	130	26	145