



## Note

These operating instructions were originally written in German and have been translated into English. Store in a safe place for future reference.

Subject to technical changes without notice. No responsibility is taken for printing or other types of errors.

## Published by

© J. Schmalz GmbH, 11.2023

This document is protected by copyright. J. Schmalz GmbH retains the rights established thereby. Reproduction of the contents, in full or in part, is only permitted within the limits of the legal provisions of copyright law. Any modifications to or abridgments of the document are prohibited without explicit written agreement from J. Schmalz GmbH.

## Contact

J. Schmalz GmbH  
Johannes-Schmalz-Str. 1  
72293 Glatten, Germany  
Tel. +49 (0) 7443 2403-0  
Fax +49 (0) 7443 2403-259  
schmalz@schmalz.de  
www.schmalz.com

Contact information for Schmalz companies and trade partners worldwide can be found at  
 [www.schmalz.com/salesnetwork](http://www.schmalz.com/salesnetwork)

<b>1</b>	<b>Safety Instructions.....</b>	<b>5</b>
1.1	Classification of Safety Instructions .....	5
1.2	Prohibition Signs.....	6
1.3	Warnings .....	6
1.4	Mandatory Symbols.....	6
1.5	General Safety Instructions .....	7
1.6	Intended Use .....	8
1.7	Note on the Type Plate.....	8
1.8	Product Key .....	9
<b>2</b>	<b>Product Description.....</b>	<b>10</b>
2.1	Functional Principle .....	10
	Description of Functions: Valve Technology SVK.....	10
2.2	Design Description .....	11
<b>3</b>	<b>Technical Data .....</b>	<b>20</b>
<b>4</b>	<b>Transport and Mounting .....</b>	<b>22</b>
4.1	Delivery.....	22
4.1.1	Items Included in Delivery .....	22
4.1.2	Checking for Completeness .....	22
4.1.3	Reporting Damage .....	22
4.2	Packaging.....	23
4.3	Removing the System from the Transportation Packaging.....	23
4.4	Storage .....	23
<b>5</b>	<b>Start of Operations and Setup.....</b>	<b>24</b>
5.1	Start of Operations .....	24
5.2	Vacuum area grippers .....	27
5.3	Connections for Functional Cover .....	27
5.4	Vacuum Connection .....	28
5.5	Connection of Adapter Set SBX.....	28
5.6	Electrical Connections .....	29
5.6.1	Solenoid Valves.....	29
5.6.2	Electrical Connection.....	29
5.6.3	LED Display in the Standard Version.....	31
5.6.4	LED Display with Impulse Valve.....	31
<b>6</b>	<b>Operation .....</b>	<b>32</b>
6.1	General notes .....	32
6.2	Control of FMHD.....	35
6.2.1	Sequential Diagram for FMHD with Separating Cylinder and “Blow off” Function.....	35
6.2.2	Sequential Diagram for the FMHD with Separating and Ventilation Cylinders .....	36
6.2.3	Functional Diagram of the Standard Version of the FMHD .....	37
6.2.4	Functional Diagram of FMHD with Ventilation Cylinder .....	37
6.2.5	Functional Diagram of FMHD with Impulse Valve.....	38

7	Troubleshooting .....	39
8	Maintenance.....	43
8.1	General Maintenance Instructions.....	43
8.2	Maintenance Schedule.....	44
8.3	External Vacuum Generator.....	45
8.4	Dust Filter .....	45
8.5	Cleaning Agents .....	45
8.6	Quick-change Plate .....	45
8.7	Valve Plate .....	46
8.8	Sealing Plate .....	46
8.9	Inspecting and Cleaning the Gripper.....	47
8.10	Overview of the Tightening Torque of the Screws .....	50
8.11	Checking the System for Leaks.....	51
9	Spare and Wearing Parts .....	52
10	Accessories.....	55
11	Pneumatic Circuit Diagram.....	56
11.1	Pneumatic Circuit Diagram of the Standard Version FMHD .....	56
11.2	Pneumatic Circuit Diagram of the FMHD with Ventilation Cylinder .....	57
11.3	Pneumatic Circuit Diagram of the FMHD with Impulse Valve .....	58
11.4	Pneumatic Circuit Diagram of the FMHD – Parallel Circuit.....	59
12	Other Applicable Documents.....	59

# 1 Safety Instructions

## 1.1 Classification of Safety Instructions

### Danger

This warning informs the user of a risk that will result in death or serious injury if it is not avoided.

 <b>DANGER</b>	
	<b>Type and source of danger</b> Consequence ▶ Remedial action

### Warning

This warning informs the user of a risk that could result in death or serious injury if it is not avoided.

 <b>WARNING</b>	
	<b>Type and source of danger</b> Consequence ▶ Remedial action

### Caution

This warning informs the user of a risk that could result in injury if it is not avoided.

 <b>CAUTION</b>	
	<b>Type and source of danger</b> Consequence ▶ Remedial action

### Attention

This warning informs the user of a risk that could result in damage to property if it is not avoided.

<b>ATTENTION</b>	
	<b>Type and source of danger</b> Consequence ▶ Remedial action

### General notes

This symbol is used when important notes and information regarding the use of the machine/the system/the device are provided.

	Note/information
---	------------------









## 1.2 Prohibition Signs

Explanation of the prohibition signs used in the operating instructions.

Icon	Description	Icon	Description
	Do not stand under suspended loads		





## 1.3 Warnings

Explanation of the warning symbols used in the operating instructions.

Icon	Description	Icon	Description
	Pollution warning		Crushing injury
	Suspended load		Hand injury warning
	Electrical voltage		General warning symbol
	Hearing damage		Warning of overpressure
	Electric shock		



## 1.4 Mandatory Symbols



Explanation of the mandatory symbols used in the operating instructions.

Icon	Description	Icon	Description
	Observe the instructions		Wear eye protection
	Use protective footwear		Activate prior to maintenance or repair
	Wear protective gloves		Wear a mask
	Use ear protectors		

## 1.5 General Safety Instructions



The system is state-of-the-art and operationally reliable. However, dangers may arise.

 <b>WARNING</b>	
	<p><b>Failure to comply with the general safety instructions</b></p> <p>Personal injuries and damage to the system</p> <ul style="list-style-type: none"><li>▶ The instruction manual contains important information on using the system. Read the instruction manual thoroughly and keep it for later reference.</li><li>▶ The system must only be used by trained personnel who have read and understood the instruction manual.</li><li>▶ This instruction manual is specific to the items included in delivery from Schmalz. These operating instructions do not take into account any modifications to the system made by the customer.</li><li>▶ The system may only be connected and operations started once the instruction manual has been read and understood.</li><li>▶ Use only the connections, mounting holes and attachment materials that have been provided.</li><li>▶ Carry out mounting or removal only when the device is in a voltage-free and depressurized state.</li><li>▶ Only qualified specialist personnel, mechanics and electricians may perform the installation. Qualified specialist personnel are persons who have received technical training and have the knowledge and experience – including knowledge of applicable regulations – necessary to enable them to recognize possible dangers and implement the appropriate safety measures while performing the installation.</li><li>▶ General safety regulations, EN standards and VDE guidelines must be observed and complied with.</li><li>▶ The gripper is to be used in combination with an automated handling system (gantry/robot). For this reason, you must also follow the safety regulations of the corresponding system.</li><li>▶ Personnel and animals are not permitted to sit or stand in the transport area.</li><li>▶ Transporting persons or animals is prohibited!</li><li>▶ No person may sit or stand in the danger zone while the machine or plant is in automatic mode. The system integrator must secure the area.</li><li>▶ It is not permitted to make changes to system components.</li><li>▶ The system may only be operated with the operating voltages specified for the corresponding components.</li><li>▶ Make sure that the workplace and surroundings are kept clean.</li><li>▶ Protect the components from damage of any kind.</li></ul>

 <b>WARNING</b>	
	<p><b>Failure to comply with the general safety instructions</b></p> <p>Personal injuries and damage to the system</p> <ul style="list-style-type: none"> <li>▶ Compressed air or a vacuum could cause closed containers to explode or implode. Check the products before use.</li> <li>▶ Do not apply suction to any dangerous dusts, oil mists, vapors, aerosols, etc.</li> <li>▶ Only use suitable and approved vacuum filters.</li> <li>▶ Do not look into the exhaust air flow of the vacuum generator.</li> </ul>

## 1.6 Intended Use

The system is used to lift and transport workpieces such as lumber, wooden components, furniture parts or similar materials that allow suction. Neutral gases in accordance with EN 983 are approved as evacuation media. Neutral gases include air, nitrogen and inert gases. The device is not suitable for manual handling. Operations using the device must take place in a secure area where no people or animals are allowed to enter.

 <b>WARNING</b>	
	<p><b>Suspended loads</b></p> <p>Personal injuries and damage to the system</p> <ul style="list-style-type: none"> <li>▶ Never stand under suspended loads.</li> </ul>

The system is mounted on the load suspension provided by the customer using the T-slots designated for this purpose. The customer also provides a control device.

The system can only be used lying horizontally. You must consult the manufacturer regarding tilted positions, as well as pivoting or tipping motions.

## 1.7 Note on the Type Plate

The type plate contains important information about the device. The type plate is firmly attached to the exterior of the device.

The type plate contains the following information:

- Part number
- Product key or gripper type
- Order number
- Year of manufacture
- Weight
- Serial number
- Ideal input pressure
- Manufacturer
- QR code with further information

The product key/gripper type or part number and year of construction are important for identifying the device. They must always be specified when ordering replacement parts, making warranty claims or making other inquiries about the device.



## 1.8 Product Key

Schmalz will be happy to advise you on selecting a gripper in order to be able to offer the best solution for your application.

The product key for configurable vacuum area grippers is made up as follows:

Example:

FMHD	CV1	840	2R28	O20	C155L	P	A60F	126	V1	CA1
1	2	3	4	5	6	7	8	9	10	11

The product key for flat suction cups with a special width (e.g. 250 mm) also contains the value for the width. Other special functions are not described in detail for the sake of clarity. We are available to answer any questions.

Example:

FMHD	CV1	840	250	2R28	O20	C155L	P	A60F	126	V1	CA1
1	2	3	12 <sup>1</sup>	4	5	6	7	8	9	10	11

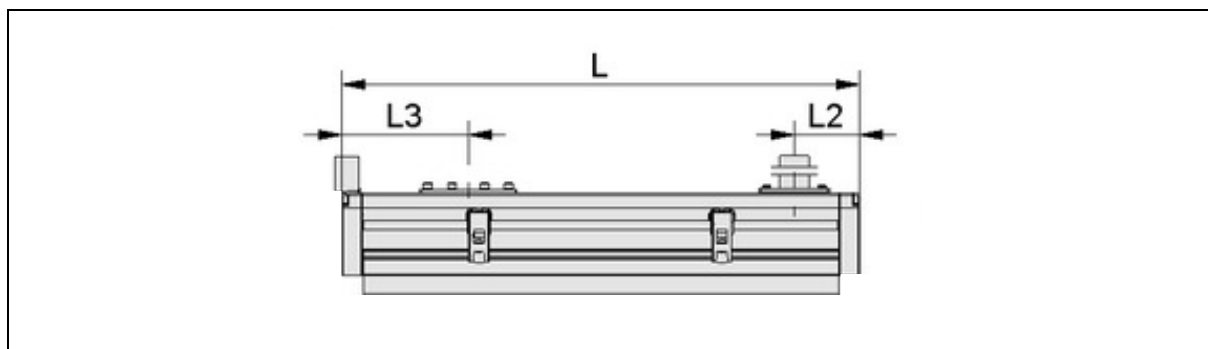

Field	Meaning	Available designs	Value in example
1	Gripper type	FMHD	FMHD
2	Check valve	CV1, CV2 (automatic assignment)	Standard version
3	Length "L"	From 350 mm to 3500mm (14 mm grid)	840 mm
4	Grid	2R28, 3R22, special grid	2R28
5	Foam type	Foam type specification – depending on the application	O20
6	Cylinder position "L3"	Measured from the left side of the enclosure to the center of the mounting plate	Left; 155 mm
7	Plate	PNP/ for impulse valve	PNP
8	Nozzle	Straight, angled, open, Cover plate	Angle = angled; Ø 60 mm, "Front" alignment
9	Nozzle position "L2"	Variable	126 mm
10	Vacuum display	Gauge, VSi, ...	Gauge
11	Compressed air connection	Plug-in nipple 7.2, Plug-in screw union	Plug-in nipple 7.2
12	Width	Standard width 170 mm/special widths <sup>1</sup>	250 mm

<sup>1</sup> The width is only specified for vacuum area grippers which are not built in the standard width of 170 mm.

<sup>2</sup> From a gripper length of 2,506 mm, two separating cylinders are used, the position is fixed.

## 2 Product Description

### 2.1 Functional Principle

The products are lifted by the area gripping system using a vacuum. The gripper is variable and can be configured individually according to customer requirements. It can be used to lift layers of boards, planks or similar workpieces/products of various sizes without adapting the suction area to the specific workpiece.

Each individual suction cell in the system is equipped with a check valve that automatically closes the suction cell when it is not in use.

The system achieves its maximum load capacity when the complete suction area is engaged with an airtight workpiece with a smooth surface. The load capacity is strongly influenced by the type of workpiece (e.g. surface, porosity, size) and the condition of the gripper or the suction elements (dirt, wear, etc.).

The automated handling system to which the system was attached by the customer is responsible for motion in the various axes.

#### Description of Functions: Valve Technology SVK

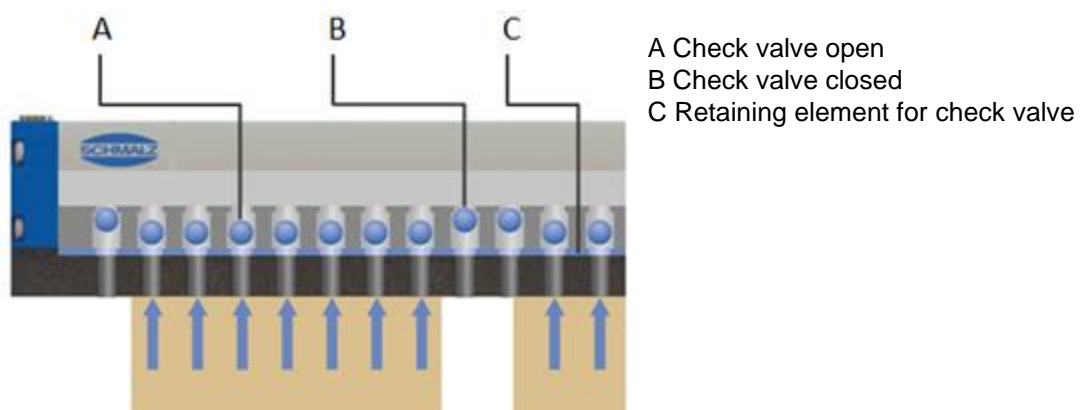

There are valves with sliders/balls in the valve plate (see Section 2.2 - G). If they are not covered by a workpiece in the moment that suction begins, the sliders/balls will close the valve. For this reason, suction may only be switched on after the gripper is placed onto the workpiece.

The closed valves (B) create an increased vacuum in the gripper which results in increased holding force on the opening valves. The sliders are held in position by a retaining element (C); the retaining element can be removed for slider maintenance.

Max. acceleration in vertical direction: 2 m/s<sup>2</sup>.



Only switch on suction when the gripper is placed on the workpiece.  
It is not possible to provide additional suction or pick up other products later.

## 2.2 Design Description

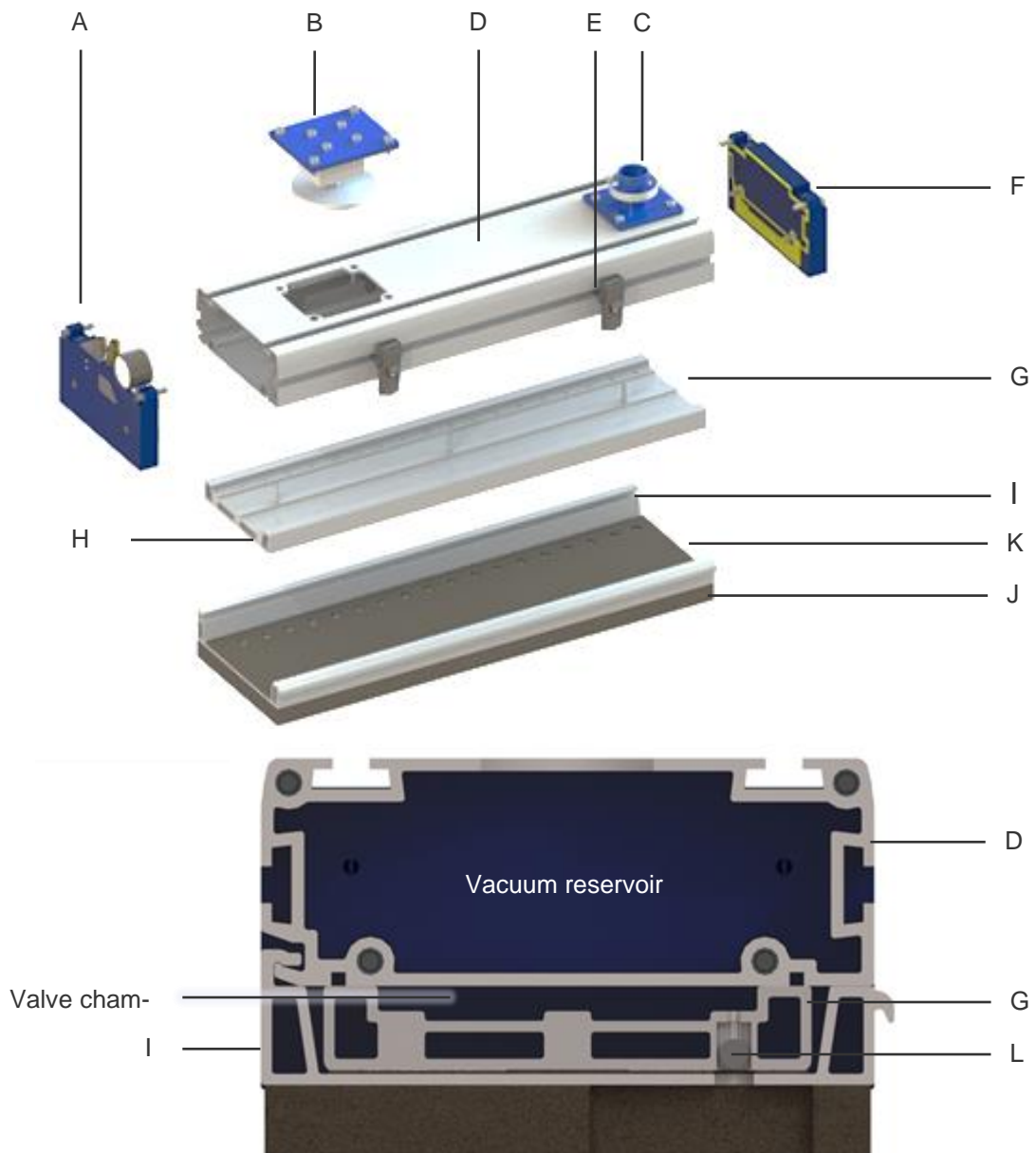

Fig. Vacuum area gripper FMHD cross-section

A	End cover with function modules
B	Separating cylinder assembly unit
C	Connection pieces for external vacuum generation
D	Base section
E	T-slot with quick-release clamps
F	End cover without function modules
G	Valve section with adhesive valve film
H	Masking film
I	Quick-change section
J	Sealing plate
K	Sealing plate
L	Slider (spherical)

## Design of the vacuum area gripper with enhanced functions

Fig. Vacuum area gripper FMHD with ejector SBPL and adapter cable for controlling the gripper and ejector

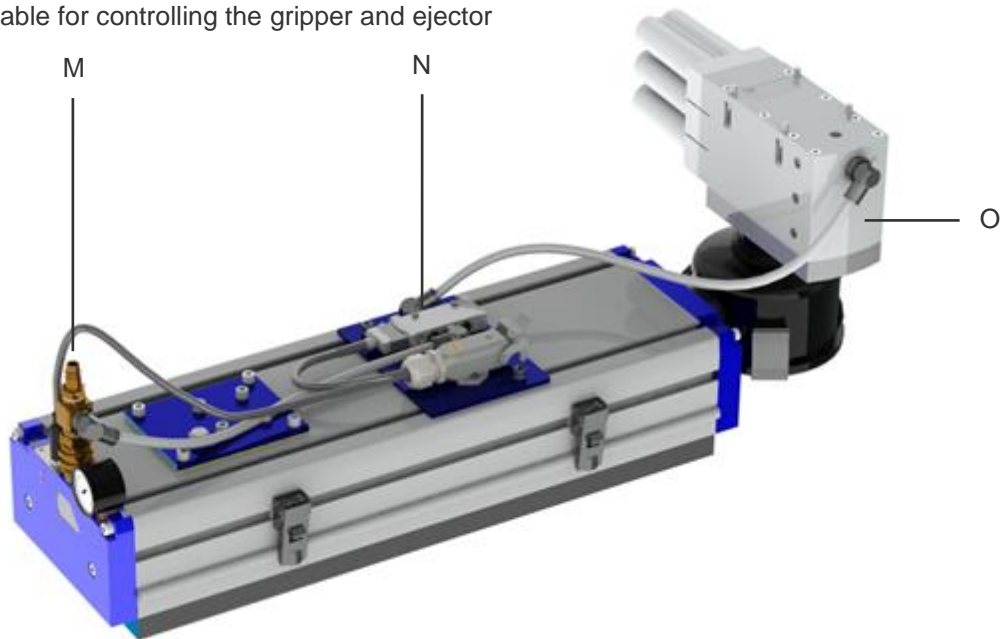
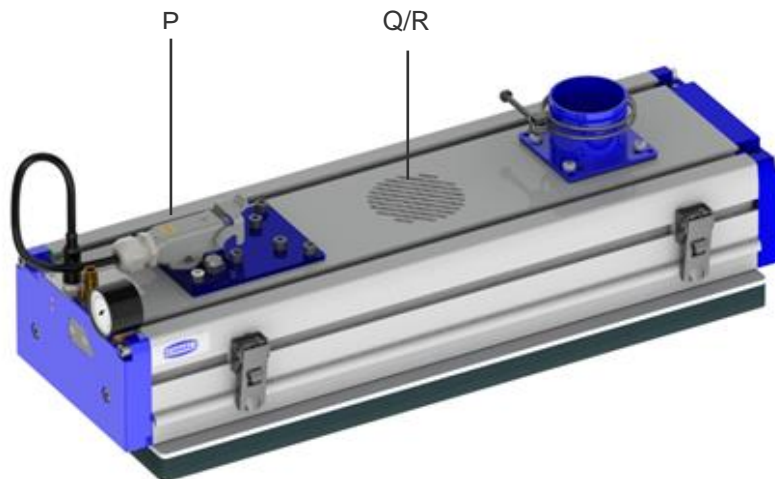

Fig. Vacuum area gripper FMHD with ventilation cylinder, widely used quick-change plate and adapter cable with Harting plug



M	Compressed air connection
N	Mounting plate for electrical connection and solenoid valve
O	End cover with ejector SBPL and filter
P	Electrical connection
Q	Ventilation opening
R	Assembly unit for ventilation cylinder (not shown)

### Main body:

#### A End Cover (with Function Modules)

The end cover with function modules (A) has a 1/4" female thread for the compressed air connection and two 1/8" threads for additional connections. A vacuum gauge or vacuum switch can be attached to connection "A." A multi-pin connector for valve control is also attached here. Only the two 1/8" threads are integrated into the opposite end cover without function modules (F); a measuring device to display the vacuum in the vacuum reservoir can be attached to both threads.



### Attention

Grub screws must not be removed. This will result in a malfunction.

In the case of grippers with a date of manufacture up to May 2022, connection B has no function – do not remove plug. In new models, this connection can be used to measure the vacuum in the reservoir (must be connected to bore 1.6).

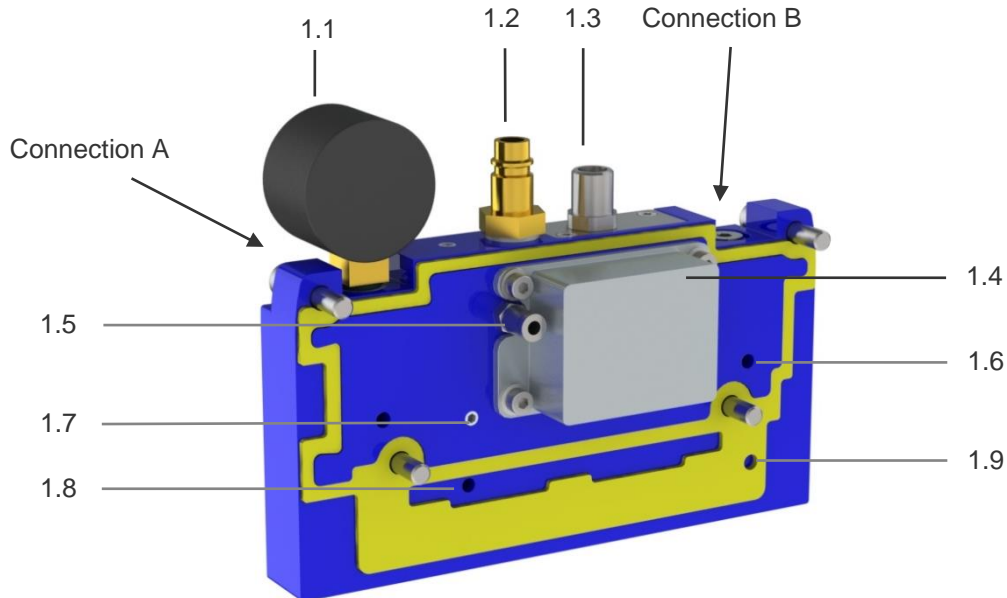

A	End cover with function modules
1.1	Connection “A” – vacuum gauge (configurable – example illustration)
1.2	Compressed air connection for vacuum area gripper (configurable – example illustration)
1.3	4-pole M12 multi-pole plug
1.4	Protective cap (under which there are two solenoid valves)
1.5	Compressed air connection for separating cylinders
1.6	Bore hole for vacuum measurement (2x) – inspect regularly for dirt
1.7	Ventilation cylinder connection (not used in the standard version – do not remove the plug)
1.8	“Blow off” connection (not used in the version with the ventilation cylinder – plug)
1.9	For covers prior to May 2022, this is connected to connection “B” and has no function/for covers after May 2022, connection “B” is connected to bore 1.9 – an additional sensor or vacuum pressure gauge can be connected

### 1.1 Connection “A” / Connection “B”

Connections A and B can be used to connect a vacuum pressure gauge (1.1) or vacuum switch. G1/8” thread.



Connection B cannot be used in versions that were supplied prior to May 2022. To check whether the connection can be used to measure the vacuum, unscrew the functional cover and check the position of bore 1.6. Connections that end at position 1.9 cannot be used.

### 1.2 Compressed Air Connection for Flat Suction Cup

The compressed air is connected via a 1/4” plug nipple DN7.2 with male thread. Recommended hose diameter is at least 9 mm. It can also be connected using a plug-in screw union.

### **1.3 Multi-Pole Plug for Connecting the Control Cable**

The integrated solenoid valves for the “Cylinder ON/OFF” and “Blow off ON/OFF” functions are connected to the control via the connection plug (M12).

Version with ventilation cylinder:

The ventilation cylinder is activated instead of the “Blow off” function.

### **1.4 Protective Cap/Solenoid Valves**

The protective cap must not be removed. The solenoid valves could be destroyed by moisture and dirt.

In the standard version and when using an ejector, two NC solenoid valves are used (24V DC). Their power consumption is 1 watt. They control the separating cylinders and the “Blow off” function.

In the version with the impulse valve, the NC valve that controls the separating cylinder is replaced by an impulse valve. In the event of a power failure, the cylinder remains in its current position. The impulse valve has a power consumption of 1.3 watts (24V DC).

### **1.5 Compressed Air Connection for the Separating Cylinder**

This connection is connected to the separating cylinder. If compressed air is applied, the cylinder extends and closes the “Suction OFF” reservoir chamber.

### **1.6 Bore Hole for Vacuum Measurement**

Connections A and B are connected to the bore holes 1.6 on both sides. (Connection B since May 2022 – see the information under 1.1)

### **1.7 Ventilation Cylinder Connection**

In the standard version, this connection is closed with a plug that must not be removed. When using a ventilation cylinder, this cylinder is connected here.

### **1.8 “Blow off” Connection**

This connection is not closed in the standard version. The compressed air flows out here when the “Blow off ON” function is activated.

When using a ventilation cylinder, the connection is closed with a plug; this plug must not be removed.

### **B Separating Cylinder Assembly Unit**

The separating cylinder assembly unit is attached to the base section of the gripper via a mounting plate (2.1) and four screws (2.2). The separating cylinder (2.3) that is mounted on the base plate connects and separates the reservoir chambers and valve chambers to and from one another. The separating cylinder is single-acting and is pneumatically operated. This unit can be easily removed from the gripper in order to check the seals or the contamination level of the gripper.

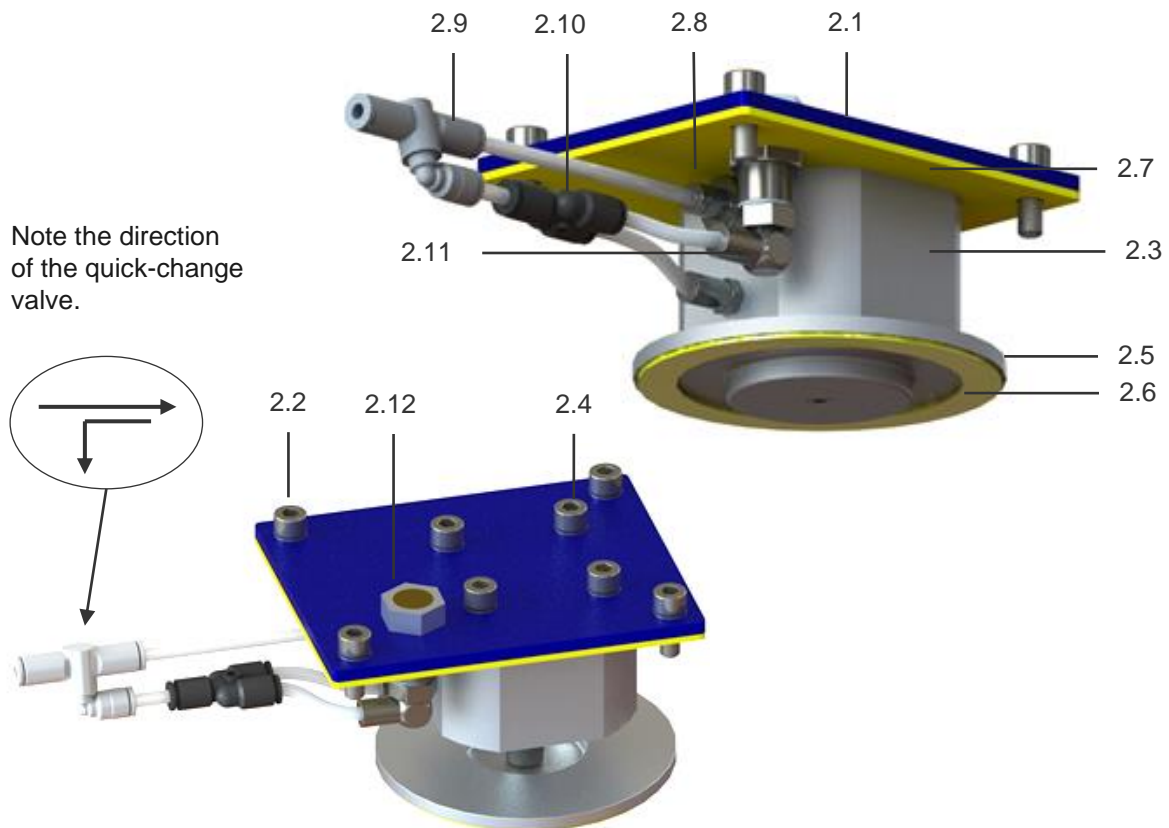

B	Separating cylinder assembly unit
2.1	Mounting plate
2.2	Screws for mounting the plate
2.3	Compact cylinder
2.4	Screws for mounting the cylinder
2.5	Sealing plate
2.6	Sealing plate sealing
2.7	Mounting plate sealing
2.8	Plug-in screw union (compressed air connection)
2.9	Quick exhaust valve (ensure that they are properly connected)
2.10	Y piece (exhaust)
2.11	Exhaust connection
2.12	Exhaust (filter)

### **C Connection Pieces for External Vacuum Generator**

The system can be operated using a blower or a pump. The system is usually connected to the external vacuum generator using a suitable vacuum hose, which can be attached at the connection piece using a hose clamp.

### **D Main Body FMHD**

The main body consists of a length-adjustable extrusion-molded aluminum section. Configurable vacuum area grippers have a length between 350 mm and 3,500 mm. On the underside of the section there is a glued-in sealing gasket on the right and left. The sealing may only protrude slightly over the section, but it must also be at least flush with the section. Together with the sealing on the end covers, this is how the “valve chamber” is sealed.

### **E Sliding Blocks**

The t-slots are used for flexible mechanical attachment of the gripper using the sliding blocks. Suitable attachment kits are listed in the “Accessories” section. The quick-release clamps are fastened to the side t-slots using sliding blocks. Additional sensors can also be attached to the side t-slots.

### **F End Cover without Function Modules**

The end cover has two connection options for measuring the vacuum in the reservoir. If necessary, a pressure gauge or sensor can be connected via the G1/8" thread.

For flat suction cups, which are supplied with an ejector, this ejector is connected via the end cover. See "O End Cover with Ejector SBPL and Filter".

### **G Valve Plate – Spare Parts Assembly**

The valve section (G) is attached to the base section (D) using M6 screws. The sliders/balls (L) are inserted into the designated bore holes and secured with an adhesive masking film (H). The entire unit can be unscrewed and removed in order to be cleaned if necessary. Without the valve section and its functional components, the gripper cannot be operated.

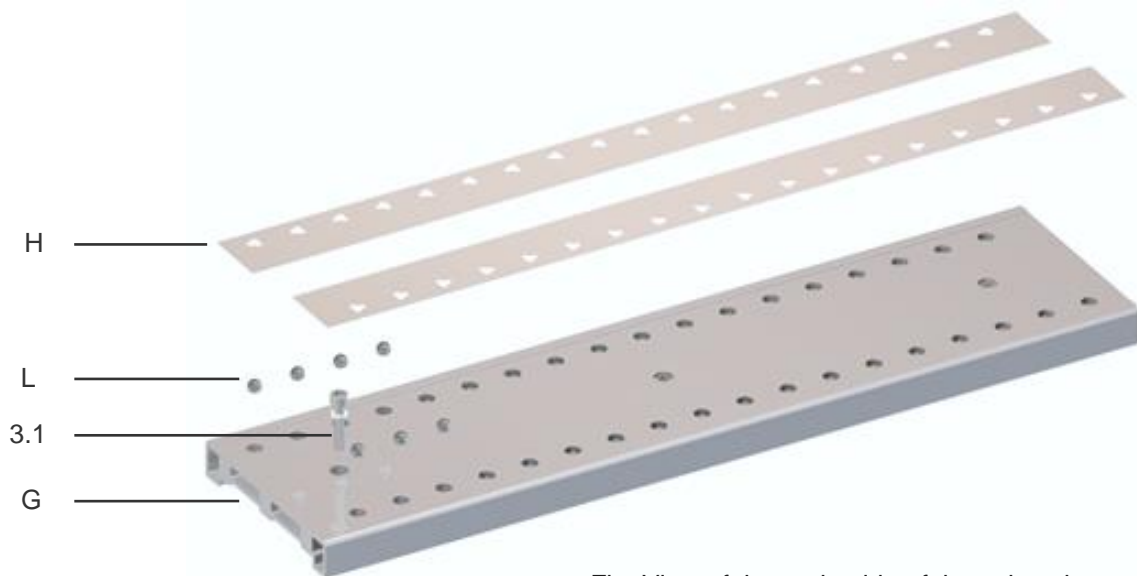

Fig. View of the underside of the valve plate

3	Valve plate – spare parts assembly
H	Masking film
L	Sliders/balls
3.1	Screw with sealing ring for attachment of the section
G	Valve section

### **H Masking Film**

Film strips with clover-shaped apertures are glued onto the bottom of the valve section to secure the sliders in their valves. These can be replaced as necessary.

### **L Sliders**

Spherical sliders are located in the valves. These sliders close the valves under which there is no workpiece. A spherical slider must be located in every valve.

### **I Quick-Change Section**

The quick-change section (I) is suspended on one side in a designated slot on the base section and fixed on the other side with quick-release clamps. The sealing plate (J) is adhered onto the bottom of the quick-change section. The sealing plate can be replaced as necessary. The sealing plate can be made of different layers and materials. A 4 mm-high sealing plate (K) is adhered on the top of the quick-change section; this sealing plate can also be replaced.

If the grippers are used in dirty environments or used to transport dirty/wet workpieces, we recommend regularly removing and cleaning or drying the sealing plate. Downtime can be reduced by using a second



identical quick-change plate while the first is being cleaned/drying. For special widths, an additional panel is attached to the quick-change profile. The sealing plate can then be attached to this additional panel.

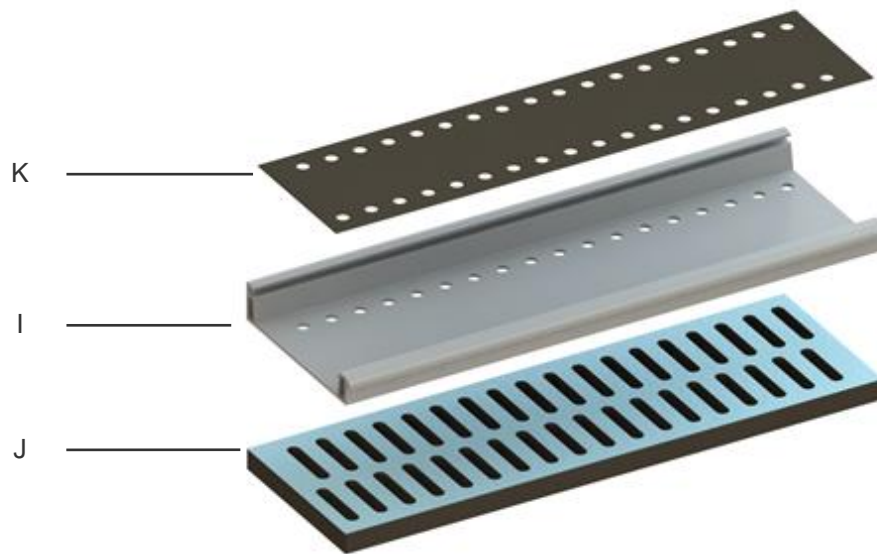

	Quick-change plate – spare parts assembly
K	Sealing plate, 4 mm
I	Quick-change section
J	Sealing plate – configurable – various materials and combinations possible depending on the application

### **J Sealing Plate**

The sealing plate (J) is adhered to the quick-change section (I). The sealing plate is made of technical foam. The standard grid is equipped with two rows of suction cells that have a distance of 28 mm from one another (designation: 2R28). The sealing plate can be quickly replaced thanks to a special adhesive film. For details, see the “Assembly” section.

#### Note on foam properties:

The technical properties and appearance of foams may vary due to production conditions. The user is responsible for testing whether a foam is suitable for a specific application. We would be happy to assist you in placing your first order by performing grip tests at our premises if you provide us with your original workpieces.

Since the foam height is also subject to tolerances, we recommend adjusting the height of the gripper every time you replace the foam. For safe use, we recommend at least 50% foam compression when picking up the workpieces in order to achieve optimal function and foam service life.

This flexing makes the foam more permeable to air. When a high number of working cycles is reached, it may be necessary to replace the foam, even if there is no visible indication of wear.

The foam may not be cleaned with a compressed-air gun. This would make the foam permeable to air in the places where compressed air was applied.

### **R Ventilation Cylinder Assembly Unit**

The ventilation cylinder assembly unit is attached to the base section of the gripper via a mounting plate (2.1) and four screws (2.2). The separating cylinder (2.3) that is mounted on the base plate connects and separates the reservoir chambers and valve chambers to and from one another. The separating cylinder is single-acting and is pneumatically operated. This unit can be removed from the gripper for maintenance.

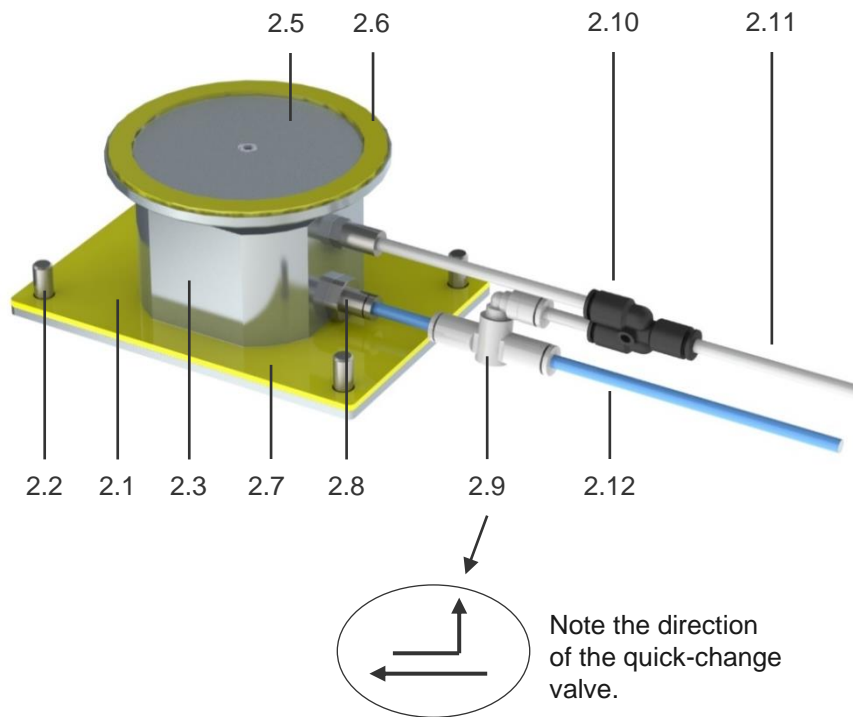

R	Ventilation cylinder assembly unit
2.1	Mounting plate
2.2	Screws for mounting the cylinder unit
2.3	Compact cylinder
2.4	Screws for mounting the cylinder (not shown)
2.5	Sealing plate
2.6	Sealing plate sealing
2.7	Mounting plate sealing
2.8	Plug-in screw union (compressed air connection)
2.9	Quick exhaust valve (ensure that they are properly connected)
2.10	Y piece (exhaust)
2.11	Exhaust connection
2.12	Compressed air connection

## **O End Cover with Ejector SBPL and Filter**

For vacuum area grippers, which are supplied with an installed ejector, this ejector is connected to the end cover together with a dust filter.

Further information about the dust filter and ejector can be found in the relevant documentation.

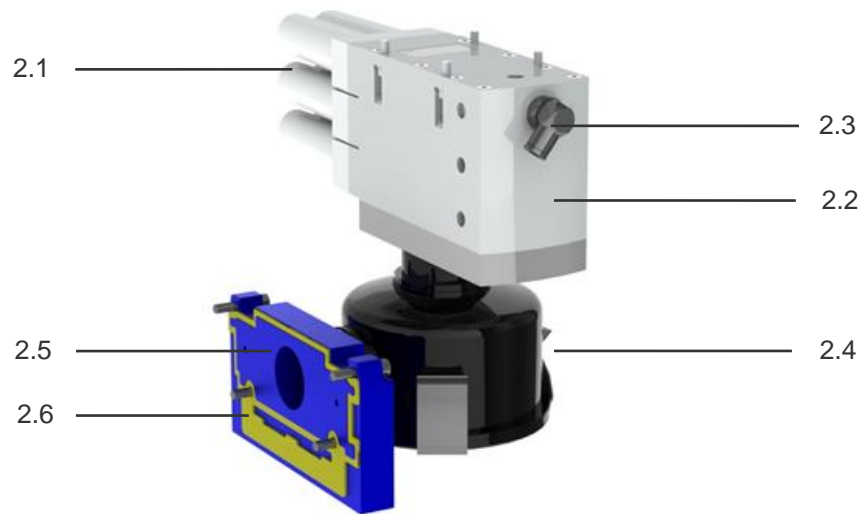

O	End cover with ejector SBPL and filter
2.1	Ejector silencer – must not be closed
2.2	Vacuum ejector SBPL
2.3	Compressed air connection for vacuum ejector
2.4	Dust filter
2.5	End cover with G1-1/4" connection thread
2.6	Form seal for housing cover

### 3 Technical Data

<b>ATTENTION</b>	
	<p><b>Non adherence to the performance limits of the gripper</b></p> <p>Malfunction and damage to the gripper and the attached components.</p> <p>► Only operate the gripper within the specified performance limits</p>

**Compressed air consumption:** approx. 30 l/min when blow off is switched on  
**Permitted compressed air range:** 4 to 7 bar – 6 bar recommended  
 If the vacuum is high and the input pressure is low, the function of the gripper may be impaired; increase the input pressure!  
**Perm. temperature range:** +5 to +40° C  
**Voltage:** 24V DC

Example vacuum area grippers	Number of suction cells	Max. degree of evacuation <sup>1</sup>	Req. suction flow rate <sup>2</sup> [l/min]	Theoretical suction force [N] <sup>3</sup>	Weight [kg]
FMHD Width: 170 mm Length: 1050 mm Grid: 2R28	70	90%	315	1,497	16
FMHD Width: 170 mm Length: 1260 mm Grid: 2R28	85	90%	378	1,818	19.5
FMHD Width: 170 mm Length: 1050 mm Grid: 3R22	132	90%	315	1,054	16
FMHD Width: 250 mm Length: 1050 mm Grid: 2R28	70	90%	315	2,637	19
FMHD Ejector: SBPL 150 HV Width: 170 mm Length: 1,050 mm Grid: 2R28	70	90%	475 <sup>4</sup>	1,497	

<sup>1</sup> At higher vacuum levels, a vacuum limiter valve must be used.  
<sup>2</sup> At a vacuum of -0.3 bar, the vacuum generator must provide the specified suction flow rate (at the vacuum connection pieces of the FMHD).  
<sup>3</sup> Calculated at -300 mbar and full-surface occupancy; vacuum -0.3 bar; actual suction force depending on the product to be gripped.  
<sup>4</sup> Suction rate of SBPL 150 HV at a vacuum of 300 mbar

Customer-specific gripper data is available on request.



**Vacuum in the gripper**  
 For workpieces typical for the application (e.g. boards), a vacuum between 300 and 400 mbar is recommended.  
 A vacuum lower than 250 mbar is not recommended.



### Permissible lift capacity

The maximum permissible lift capacity per gripper is 500 kg when the gripper is connected in accordance with the manufacturer's specifications.

**This is particularly important for grippers with extra wide quick-change plates!**

The maximum permissible load capacity is not the same as the suction force because the suction force varies based on the workpiece and vacuum.

## Dimensions

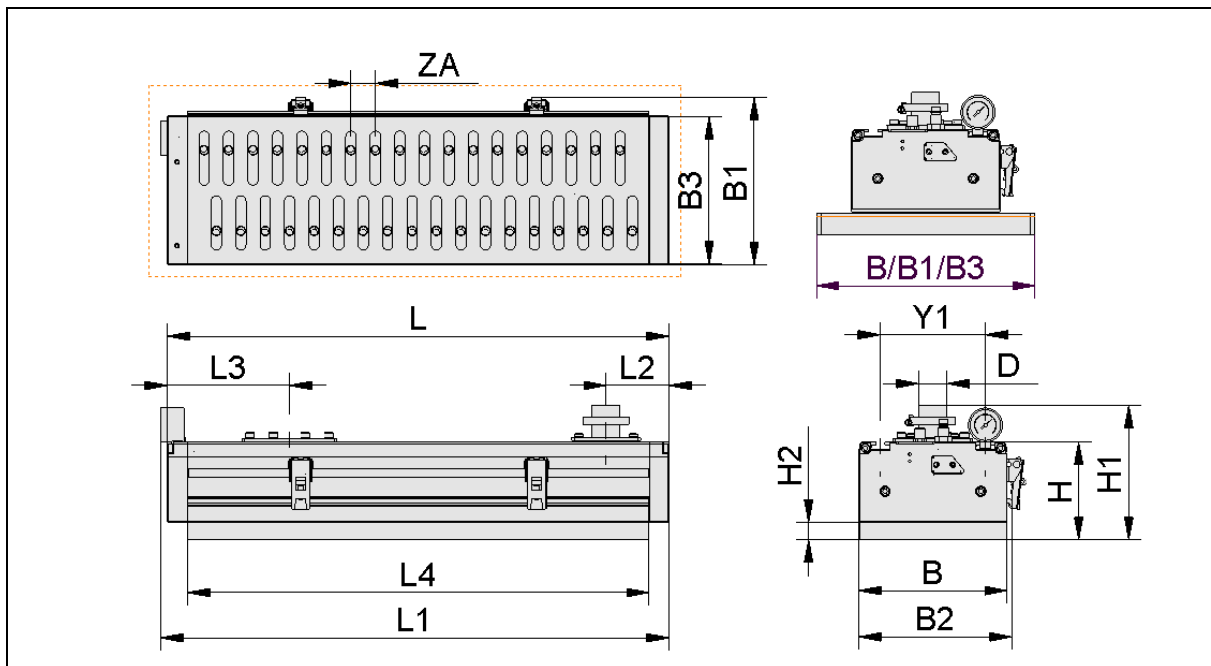

### Vacuum area gripper examples (product key)

Standard width gripper

FMHD CV1 1050 2R28 O20 C152L P S60 126 V1 CA1

Extra wide gripper

FMHD 250 CV 1 1050 2R28 O20 C138L P S60 126 V1

Gripper with 3R22 grid

FMHD CV2 1050 3R22 O20 C152L P S60 126 V1 CA1

### Dimensions

H	H1 <sup>1</sup>	H2 <sup>2</sup>	L	L1	L2	L3	D
111.6	158.6	20	1,050	1,057.8 <sup>3</sup>	126	152	60
116.6	163.6	20	1,050	1,057.8 <sup>3</sup>	126	138	60
111.6	158.6	20	1,050	1,057.8 <sup>3</sup>	126	152	60
L4 <sup>4</sup>	B <sup>5</sup>	B1 <sup>6</sup>	B2 <sup>7</sup>	B3 <sup>8</sup>	Y	ZA	
1,004	170	191.3	175.5	168	120	28	
1,004	250	250	175.5	250	120	28	
1,004	170	191.3	175.5	168	120	22	

Gray-highlighted fields are fixed dimensions for all grippers.

<sup>1</sup> Maximum overall height

<sup>3</sup> Analog gauge protrudes slightly

<sup>5</sup> Nominal width of gripper

<sup>7</sup> Width of quick-change section including suspension device

<sup>2</sup> Depending on the material of the sealing plate





<sup>4</sup> Length of sealing plate

<sup>6</sup> Maximum width

<sup>8</sup> Width of sealing plate

## 4 Transport and Mounting

ATTENTION	
	<p><b>Incorrect disposal of the system or individual components</b></p> <p>Environmental damage</p> <ul style="list-style-type: none"><li>▶ Disposal according to national guidelines.</li></ul>

WARNING	
   	<p><b>Improper securing of the load</b></p> <p>Improper unloading and transport can result in personal injuries and damage to property. Moving loads can tip over, fall or crush people. When lifting transport units, parts can fall over, move or fall down. Danger to life and limb.</p> <ul style="list-style-type: none"><li>▶ Only transport loads that are sufficiently secured against slipping.</li><li>▶ Only transport/attach vacuum area grippers with corresponding lifting and attachment equipment</li><li>▶ Ensure that all persons leave the hoist danger zone before the transport units are lifted.</li><li>▶ Wear protective footwear and additional safety equipment if necessary.</li><li>▶ Only trained personnel who have received safety instructions may unload and transport the product.</li></ul>

### 4.1 Delivery

#### 4.1.1 Items Included in Delivery

For the exact items included in delivery, please refer to the order confirmation. The delivery documents list the shipping weight and dimensions. Note the system weight and dimensions when choosing suitable lifting equipment.

	<p><b>Note</b></p> <p>The instruction manual is part of the system and must be kept with the system every time it is relocated.</p>
---	---

#### 4.1.2 Checking for Completeness

Using the enclosed delivery documents, check the entire shipment to ensure that it is complete. Also refer to our Terms and Conditions of Sale and Delivery.

#### 4.1.3 Reporting Damage

After delivery of the shipment, damage due to faulty packaging or transport must be reported immediately to the carrier and J.Schmalz GmbH.

## 4.2 Packaging

The system is shipped in a transport box made specifically for the system.

## 4.3 Removing the System from the Transportation Packaging

The transportation packaging must be opened carefully. Remove the product. Attach a suitable lifting device to the system.

Now lift the system so that it is freely suspended after all other packaging elements are removed.







## 4.4 Storage

The system must be stored in its original packaging as long as it is not being used and is to be stored for any period of time.





<b>ATTENTION</b>	
	<p><b>Incorrect storage of the system</b></p> <p>Material damage to the system</p> <p>▶ The system may only be stored as described in the instruction manual.</p>



# 5 Start of Operations and Setup





## 5.1 Start of Operations

 <b>CAUTION</b>	
	<p><b>General notes on the start of operations</b></p> <p>Risk of injury</p> <ul style="list-style-type: none"> <li>▶ The system integrator must secure the danger zone.</li> <li>▶ The production system must be stopped in the area where the system is being set up.</li> <li>▶ The system may only be set up at the workplace in accordance with the instruction manual.</li> <li>▶ The system must be disconnected and depressurized during setup.</li> <li>▶ The production system must be secured to prevent activation during setup.</li> </ul>
 	<p><b>Approach of a moving element to a fixed part/machinery mobility/moving elements</b></p> <p>Body parts could be crushed, sucked in or caught if the vacuum area gripper is abruptly attached to a workpiece or a surface or by moving parts.</p> <ul style="list-style-type: none"> <li>▶ Do not place any body parts between the bottom of the gripper and a surface.</li> </ul>
	<p><b>High pressure</b></p> <p>Placement/release of compressed air lines</p> <ul style="list-style-type: none"> <li>▶ The system integrator must secure the danger zone.</li> <li>▶ Regularly inspect the gripper and perform regular maintenance in order to detect and replace porous compressed air lines in good time. Replace defective connectors.</li> </ul>
	<p><b>Stored energy/vacuum</b></p> <p>Body parts could be crushed, cut, sucked in, caught or sliced if the flat suction cup is abruptly attached to a workpiece or a surface.</p> <ul style="list-style-type: none"> <li>▶ Do not place any body parts between the bottom of the gripper and a surface.</li> <li>▶ Eyes can be sucked in; do not look into open vacuum openings.</li> </ul>
	<p><b>Conductive parts/parts that have become live in an error state/short circuits</b></p> <p>Electric shock</p> <ul style="list-style-type: none"> <li>▶ Regularly inspect and perform maintenance on the gripper to detect and repair wear or faulty connections in good time.</li> </ul>
	<p><b>Moisture</b></p> <p>Very wet workpieces can permanently impair the function of the gripper</p> <ul style="list-style-type: none"> <li>▶ Only grip dry workpieces if possible</li> <li>▶ Regularly clean and, if necessary, dry the gripper</li> </ul>



 <b>CAUTION</b>	
 	<p><b>Noise hazards due to the exhaust system or gas flowing at high speeds or worn parts</b></p> <p>Discomfort, tinnitus, stress, exhaustion due to constant/high noise levels</p> <ul style="list-style-type: none"> <li>▶ If possible, switch off vacuum generators and the blow off function when not in use in order to reduce noise pollution.</li> <li>▶ Wear personal protective equipment e.g. ear protectors</li> <li>▶ If possible, position vacuum generators far enough away from machine operators; use additional silencers</li> <li>▶ Regularly inspect and perform maintenance on the system in order to ensure that it works properly.</li> </ul>
	<p><b>Careless use of personal protective equipment</b></p> <p>Danger to the operator</p> <ul style="list-style-type: none"> <li>▶ Adapt and wear appropriate personal protective equipment based on the task being performed.</li> </ul>
	<p><b>Dust and fog</b></p> <p>Reduced visibility/difficulty breathing</p> <ul style="list-style-type: none"> <li>▶ Keep the environment clean wherever possible; avoid kicking up large amounts of dust.</li> </ul>

 <b>WARNING</b>	
	<p><b>System setup by untrained personnel</b></p> <p>Serious personal injury</p> <ul style="list-style-type: none"> <li>▶ The system must only be set up by trained personnel who have read and understood the operating instructions.</li> </ul>
	<p><b>Non-compliance with work safety instructions</b></p> <p>Personal injuries and damage to the system</p> <ul style="list-style-type: none"> <li>▶ The device may only be started up in a secure area which no people are allowed to enter.</li> <li>▶ Never lift loads at an angle and never drag them.</li> <li>▶ Do not tear off stuck loads.</li> <li>▶ Only pick up and lift suitable loads (check inherent stability and surface density).</li> <li>▶ Only set workpieces down on clear, even surfaces due to the danger of slipping.</li> <li>▶ Do not release the load until it rests completely and safely on a secure surface.</li> <li>▶ Do not come close to the load when releasing/depositing it and do not touch it.</li> </ul>

 <b>DANGER</b>	
 	<p><b>General safety notes on the start of operations</b></p> <p>Danger to life and limb</p> <ul style="list-style-type: none"> <li>▶ The system must only be set up by trained personnel who have read and understood the operating instructions.</li> <li>▶ The system integrator must secure the danger zone.</li> <li>▶ The production system must be stopped in the area where the system is being set up.</li> <li>▶ The system may only be set up at the workplace in accordance with the operating instructions.</li> <li>▶ The system must be disconnected during setup.</li> <li>▶ The production system must be secured to prevent activation during setup.</li> </ul>
	<p><b>Acceleration/deceleration/kinetic energy</b></p> <p>Danger to life and limb</p> <ul style="list-style-type: none"> <li>▶ See general safety notes on the start of operations</li> </ul>
 	<p><b>Danger of falling objects/gravity</b></p> <p>Danger to life and limb</p> <ul style="list-style-type: none"> <li>▶ See general safety notes on the start of operations</li> <li>▶ Never stand under suspended loads.</li> </ul>
	<p><b>Human error</b></p> <p>Danger to life and limb</p> <ul style="list-style-type: none"> <li>▶ Adhere to the instruction manual</li> </ul>



## 5.2 Vacuum area grippers

The system is mounted on the load suspension device provided by the customer (e.g. a gantry crane or robot) using the T-slots designated for this purpose. The customer also provides a control device.

The suspension should be designed to allow the system to adapt flexibly to the workpieces when it is placed on them (e.g. spring-mounted or floating suspension).

The system must be attached securely, taking the weight of the system and its maximum load-bearing capacity into account.

We recommend securing the vacuum area grippers with at least two connection points for every four sliding blocks.

 <b>CAUTION</b>	
	<p><b>Static electricity</b></p> <p>Electric shock, defect in the system</p> <p>▶ Do not connect the gripper to the handling device with an insulating intermediate piece.</p>

## 5.3 Connections for Functional Cover

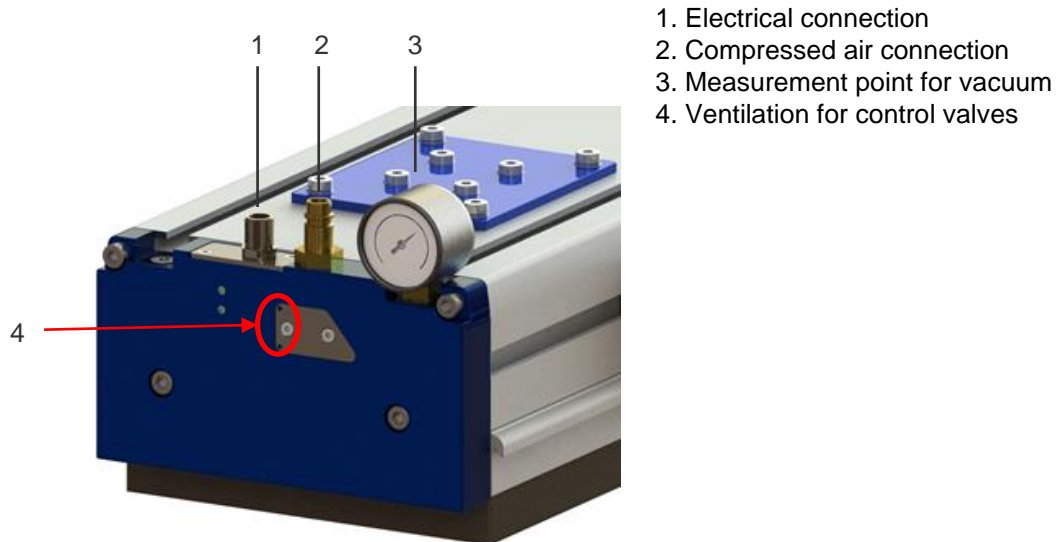

The compressed air is connected using the quick-connect coupling, which is located on the sealing plate and is included in delivery. Requirements for the compressed air provided by the customer:

- Dry, filtered air in acc. with ISO 8573-1:2010 [7:4:4]
- Constant operating pressure: 6 bar

If you select a supply hose that is too small, the compressed air supplied to the pneumatic elements will not be enough for optimal operation.



### Maximum overpressure

The maximum overpressure in the gripper during “blow off” (vacuum reservoir or valve chamber) must be limited to a maximum of 0.2 bar.



### Ventilation

The opening for ventilating the control valve may not be closed.

## 5.4 Vacuum Connection

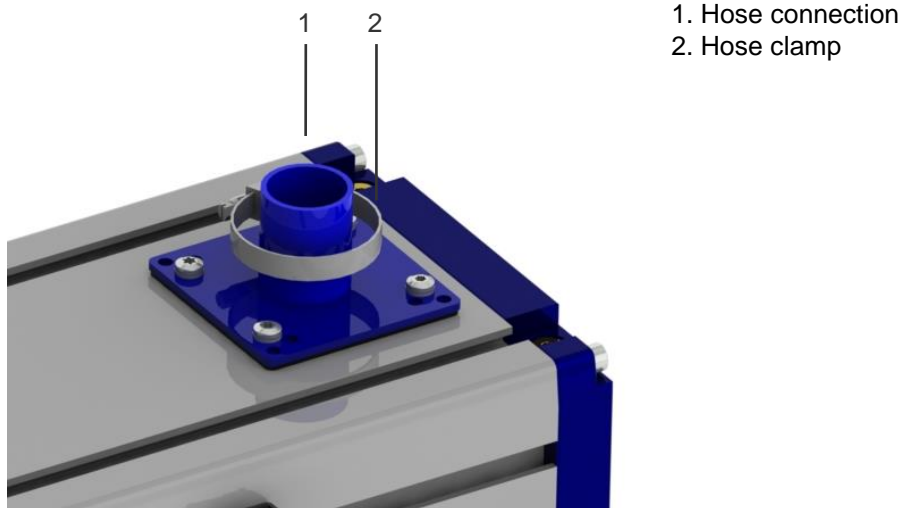

A hose that is suitable for vacuum applications must be connected at the installed hose connection and secured with a suitable hose clamp. The supply hose must have the same nominal diameter as the installed connection. The maximum recommended hose length is around 10 meters. A reduction of the internal hose diameter or the use of longer hoses could impair the functionality of the system.



### **Vacuum**

Once vacuum is applied in a gripper, it immediately begins suction when the cylinder is open.

## 5.5 Connection of Adapter Set SBX

Customers that are using the vacuum area gripper SBX can replace it with the gripper FMHD, which was designed especially for this purpose, if the vacuum area gripper becomes damaged.

It can be replaced 1:1 in the existing system with an adapter cable and additional mechanical conversion measures.

To do so, you attach the vacuum area gripper FMHD to the existing flange using the supplied washers. Connect the compressed air coupling and Harting plug in the same way as before. The adapter cable is designed to ensure the control unit does not have to be modified.

## 5.6 Electrical Connections

### 5.6.1 Solenoid Valves

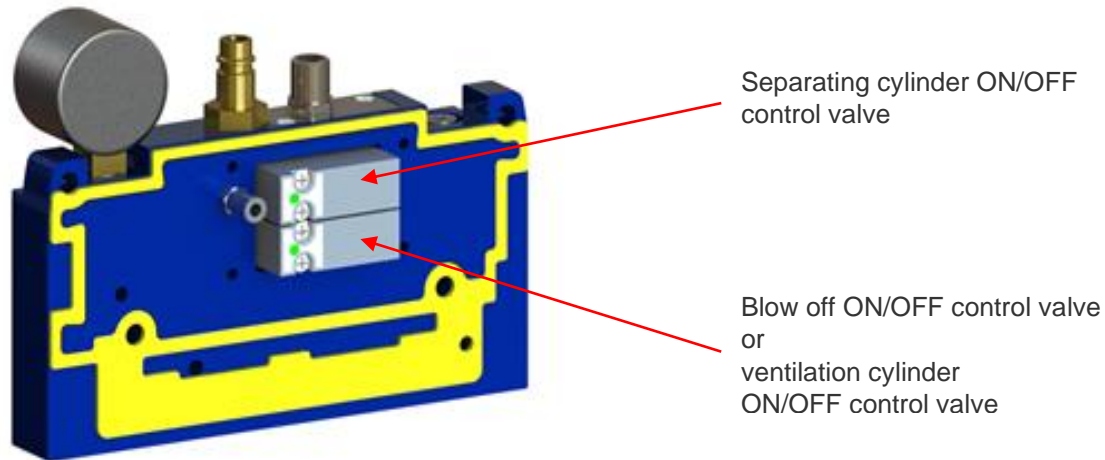

View of the housing cover when the protective cap is removed

The solenoid valves (NC) control the separating cylinder as well as the blow off function and/or the ventilation cylinder. The customer is responsible for the control system.

In the version with the impulse valve, the upper NC solenoid valve (separating cylinder control) is replaced by an impulse valve. This ensures that the separating cylinder remains in its current switching state in the event of a power failure.

The pin assignments for control of the solenoid valves can be found in the pin assignment diagram in the following section.



### 5.6.2 Electrical Connection

The connection for controlling the solenoid valve is established using a 4-pin M12 connector that is integrated into the end cover. 24V DC  $\pm$  10%, max. power consumption 2 W (2.3 W when using the impulse valve), rated current 0.1 A.

Standard = PNP switching.

The plug connectors must not be connected or disconnected when the system is live.

The power supply and signal inputs have a maximum line length of 30 meters.

 <b>DANGER</b>	
 	<p><b>Inappropriate voltage supply</b></p> <p>Electric shock, destruction of the electrical components</p> <ul style="list-style-type: none"><li>▶ Connection work may only be carried out by a qualified electrical specialist.</li><li>▶ The system must incorporate a safe electrical cut-off of the power supply in compliance with EN 60204.</li><li>▶ Do not connect or disconnect the plug connectors when live.</li><li>▶ Only operate the system with protected extra-low voltage.</li></ul>





Observe the separate instruction manual when connecting the vacuum generator.

Plug FMHD	Pin	Litz wire color	Function (PNP)
	1	Brown	Not used
	2	White	“Blow off” signal input or ventilation cylinder (= depositing workpieces)
	3	Blue	Ground
	4	Black	“Suction” signal input (= controlling the separating cylinder)

### Adapter set SBX

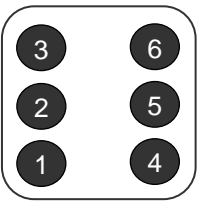
When using an FMHD with an adapter set, the pin assignments for the Harding plug correspond to those of the SBX. It is therefore not necessary to adapt the system control unit to the FMHD.

Plug for the adapter set SBX with ventilation cylinder	Pin	Function (PNP)
	1	“Suction” signal input (= controlling the separating cylinder)
	2	“Blow off” signal input (= depositing workpieces)
	3	Ground
	4	Not used
	5	Ground
	6	Not used

Plug for the adapter set SBX with ejector SBPL	Pin	Function (PNP)
	1	“Suction” signal input (= controlling the separating cylinder)
	2	“Vent” signal input (= depositing workpieces)
	3	Ejector signal input (= switching on the vacuum generator)
	4	Not used
	5	Ground (PIN 1+2)
	6	Ground (PIN 3)

## ATTENTION

### Incorrectly connected screw union

Malfunction

- ▶ The multi-pole plug's screw union must be sealed securely and correctly during installation of the customer's cable.

### 5.6.3 LED Display in the Standard Version

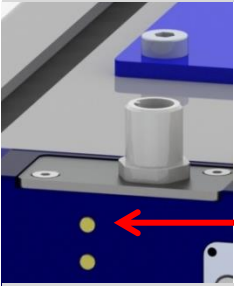
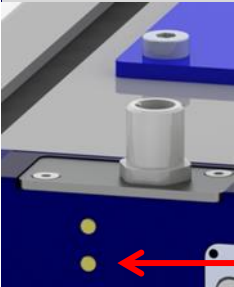

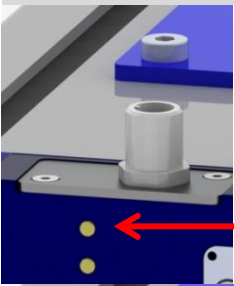
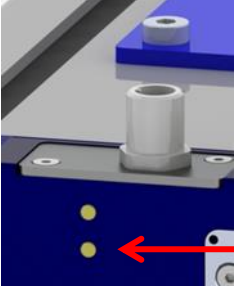

LED	Status	Valve status
 <p>Separating cylinder</p>	LED illuminated	ON - "Separating cylinder extended" (reservoir and valve chamber separated – suction not applied)
	LED not illuminated	OFF - "separating cylinder retracted" (suction applied)
 <p>Blow off/ ventilation cylinder</p>	LED illuminated	ON - "blow off switched on" (depositing the workpiece) or ventilation cylinder extended (applying suction to the workpiece)
	LED not illuminated	OFF - "blow off switched off" (suction applied)/ or "ventilation cylinder retracted" (depositing the workpiece)

### 5.6.4 LED Display with Impulse Valve





LED	Status	Valve status
 <p>Separating cylinder</p>	LED illuminated	"Cylinder OFF" (suction applied)
	LED not illuminated	"Extend cylinder ON" (reservoir and valve chamber separated – suction not applied)
 <p>Blow off/ ventilation cylinder</p>	LED illuminated	"Blow off/vent ON" (depositing the workpiece)
	LED not illuminated	"Blow off/vent OFF"



# 6 Operation





## 6.1 General notes

 <b>CAUTION</b>	
	<p><b>General notes on operation</b> Risk of injury</p> <ul style="list-style-type: none"> <li>▶ The system integrator must secure the danger zone.</li> <li>▶ The system may only be operated at the workplace in accordance with the operating instructions.</li> </ul>
	<p><b>Approach of a moving element to a fixed part/machinery mobility/moving elements</b></p> <p>Body parts could be crushed, sucked in or caught if the vacuum area gripper is abruptly attached to a workpiece or a surface or by moving parts.</p> <ul style="list-style-type: none"> <li>▶ Do not place any body parts between the bottom of the gripper and a surface.</li> </ul>
	<p><b>High pressure</b> Placement/release of compressed air lines</p> <ul style="list-style-type: none"> <li>▶ The system integrator must secure the danger zone.</li> <li>▶ Regularly inspect the gripper and perform regular maintenance in order to detect and replace porous compressed air lines in good time. Replace defective connectors.</li> </ul>
	<p><b>Stored energy/vacuum</b></p> <p>Body parts could be crushed, cut, sucked in, caught or sliced if the vacuum area gripper is abruptly attached to a workpiece or a surface.</p> <ul style="list-style-type: none"> <li>▶ Do not place any body parts between the bottom of the gripper and a surface.</li> <li>▶ Eyes can be sucked in; do not look into open vacuum openings.</li> </ul>
	<p><b>Conductive parts/parts that have become live in an error state/short circuits</b> Electric shock</p> <ul style="list-style-type: none"> <li>▶ Regularly inspect and perform maintenance on the gripper to detect and repair wear or faulty connections in good time.</li> </ul>
	<p><b>Moisture</b></p> <p>Very wet workpieces can permanently impair the function of the gripper</p> <ul style="list-style-type: none"> <li>▶ Only grip dry workpieces if possible</li> <li>▶ Clean the gripper regularly and dry the foam if necessary</li> </ul>



 <b>CAUTION</b>	
 	<p><b>Noise hazards due to the exhaust system or gas flowing at high speeds or worn parts</b></p> <p>Discomfort, tinnitus, stress, exhaustion due to constant/ high noise levels</p> <ul style="list-style-type: none"> <li>▶ If possible, switch off vacuum generators and the blow off function when not in use in order to reduce noise pollution.</li> <li>▶ Wear personal protective equipment e.g. ear protectors</li> <li>▶ If possible, position vacuum generators far enough away from machine operators; use additional silencers</li> <li>▶ Regularly inspect and perform maintenance on the system in order to ensure that it works properly.</li> </ul>
	<p><b>Careless use of personal protective equipment</b></p> <p>Danger to the operator</p> <ul style="list-style-type: none"> <li>▶ Adapt and wear appropriate personal protective equipment based on the task being performed.</li> </ul>
	<p><b>Dust and fog</b></p> <p>Reduced visibility/difficulty breathing</p> <ul style="list-style-type: none"> <li>▶ Keep the environment clean wherever possible; avoid kicking up large amounts of dust.</li> </ul>

 <b>WARNING</b>	
	<p><b>System operation by untrained personnel</b></p> <p>Serious personal injury</p> <ul style="list-style-type: none"> <li>▶ The system may only be operated by trained personnel who have read and understood the operating instructions.</li> </ul>
	<p><b>Non-compliance with work safety instructions</b></p> <p>Personal injuries and damage to the system</p> <ul style="list-style-type: none"> <li>▶ The device may only be started up in a secure area which no people are allowed to enter.</li> <li>▶ Never lift loads at an angle and never drag them.</li> <li>▶ Do not tear off stuck loads.</li> <li>▶ Only pick up and lift suitable loads (check inherent stability and surface density).</li> <li>▶ Only set workpieces down on clear, even surfaces due to the danger of slipping.</li> <li>▶ Do not release the load until it rests completely and safely on a secure surface.</li> <li>▶ Do not come close to the load when releasing/depositing it and do not touch it.</li> </ul>

 <b>DANGER</b>	
 	<p><b>General safety notes on operation</b></p> <p>Danger to life and limb</p> <ul style="list-style-type: none"> <li>▶ The system may only be operated by trained personnel who have read and understood the operating instructions.</li> <li>▶ The system integrator must secure the danger zone.</li> <li>▶ The system may only be operated at the workplace in accordance with the instruction manual.</li> </ul>
	<p><b>Acceleration/deceleration/kinetic energy</b></p> <p>Danger to life and limb due to workpieces slinging away or the system traversing.</p> <ul style="list-style-type: none"> <li>▶ See general safety notes on the start of operations</li> <li>▶ Maintain sufficient distance to the moving system/workpiece in order to avoid danger, even in the case of unforeseeable events (e.g. emergency stop)</li> </ul>
 	<p><b>Danger of falling objects/gravity due to falling objects</b></p> <p>Danger to life and limb</p> <ul style="list-style-type: none"> <li>▶ See general safety notes on the start of operations</li> <li>▶ Never stand under suspended loads.</li> <li>▶ Do not place any body parts under the suspended load or the system.</li> <li>▶ The system's maximum permitted lift capacity must not be exceeded.</li> </ul>
	<p><b>Human error</b></p> <p>Danger to life and limb</p> <ul style="list-style-type: none"> <li>▶ Adhere to the instruction manual</li> </ul>
	<p><b>Switching components that are not explosion-proof</b></p> <p>Risk of fire and explosion</p> <ul style="list-style-type: none"> <li>▶ The product must not be used in explosion risk areas.</li> </ul>

Consult the manufacturer before operating it at ambient temperatures higher or lower than the permitted temperatures.

The system can only achieve its maximum lift capacity if it is completely covered by an airtight workpiece. For the maximum permitted load, see the Technical Data.

## 6.2 Control of FMHD

The sequence of a lifting process differs based on the integrated function and valve type used. You can find the relevant information about this subject in the sections below.



### Optimized control

Only turn on the suction when workpieces are being lifted. Otherwise, additional dust from the environment is drawn in, which could shorten the necessary maintenance intervals.

### 6.2.1 Sequential Diagram for FMHD with Separating Cylinder and “Blow off” Function

Vacuum area grippers FMHD are equipped with a separating cylinder and the “Blow off” function as standard. Oversized grippers of over 2,500 mm have two separating cylinders, but the lifting process sequence is identical.

<p><u>Simplified diagram of a gripper cross-section</u></p> <p>           → Vacuum reservoir            → Compact cylinder (extended; vacuum reservoir and valve chamber separated)            → Valve chamber            → Sealing foam            → Workpiece         </p>	
<p><b>Pretensioning</b></p>	<p>Before the suction process starts, the vacuum reservoir integrated into the suction bar must be evacuated. The amount of time this process takes varies based on the suction bar type, vacuum generator capacity and the length. Generally, this process is started approximately 0.5 to 5 seconds before picking up the load.</p> <p>When the “Separating cylinder” control valve is activated, the cylinder piston rod extends and separates the vacuum reservoir from the valve chamber. Vacuum is generated in the reservoir chamber when the vacuum generator is switched on.</p>
<p><b>Applying suction</b></p>	<p>Once the sealing mat has been placed on the workpiece and is compressed, the system can start picking it up.</p> <p>To do so, the “Separating cylinder” control valve is reset (LED is not illuminated). The cylinder’s piston rod is retracted and the load is picked up. The load can then be transported once the necessary vacuum level is reached.</p>
<p><b>Depositing</b></p>	<p>Once the workpiece has been transported and set down, it must be deposited.</p> <p>For this purpose, the separating cylinder control valve is activated (upper LED lights up). The cylinder’s piston rod extends and separates the valve chamber from the reservoir chamber.</p> <p>The “Blow off” control valve is also activated (lower LED lights up). This causes the vacuum in the valve chamber to break down and the workpiece to be released from the sealing mat.</p>



The cylinder is retracted when no voltage is applied. In this way, the reservoir and suction chamber are connected.

### 6.2.2 Sequential Diagram for the FMHD with Separating and Ventilation Cylinders

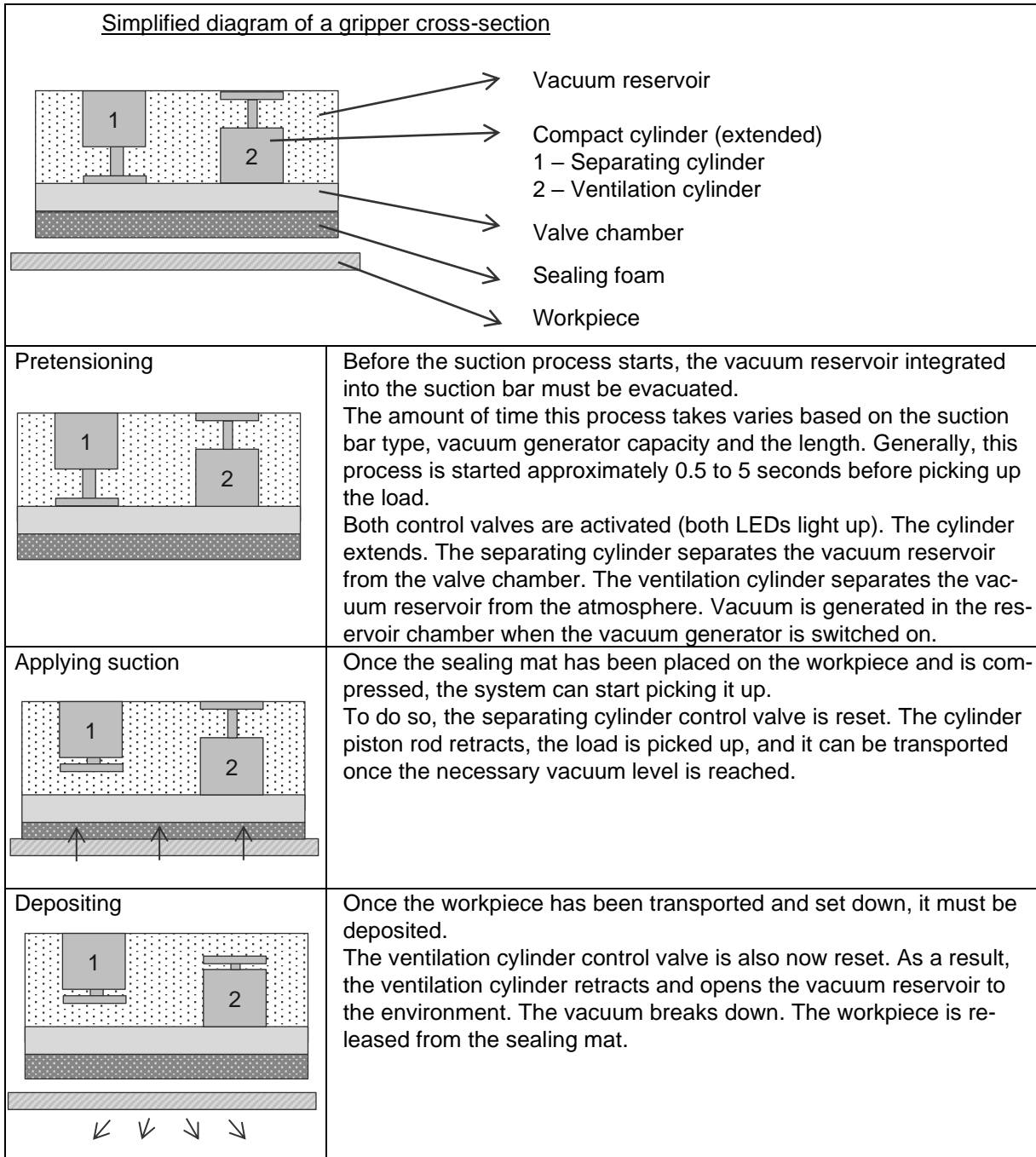

Both cylinders are retracted when no voltage is applied. See the “Depositing” state.

### 6.2.3 Functional Diagram of the Standard Version of the FMHD

Using:

- Separating cylinder
- "Blow off" function
- Two NC control valves



**Duration of the "blow off" compressed air pulse**

Depending on the workpiece, the blow off process should last for roughly three to five seconds.

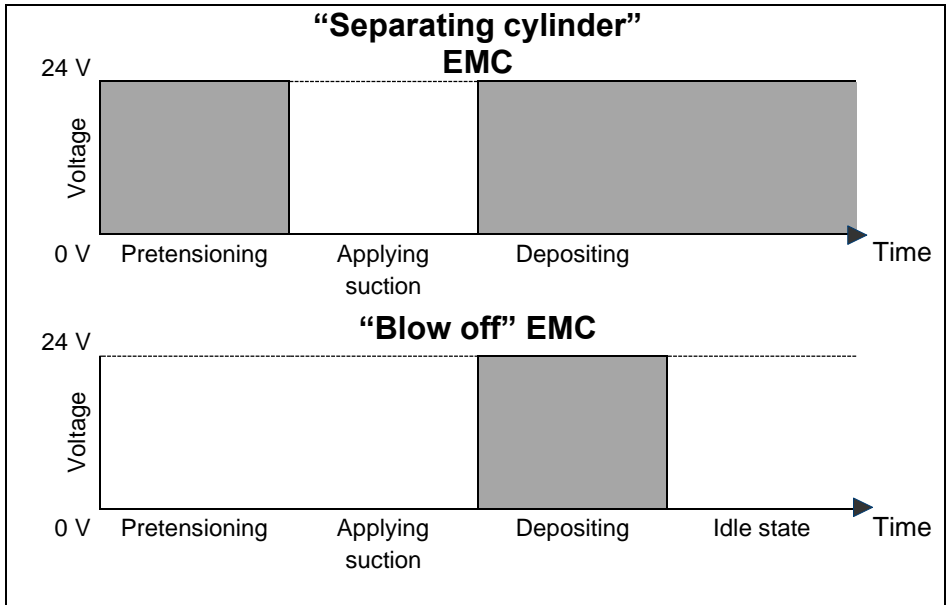

### 6.2.4 Functional Diagram of FMHD with Ventilation Cylinder

Using:

- Separating cylinder
- Ventilation cylinder instead of "Blow off" function
- Two NC control valves

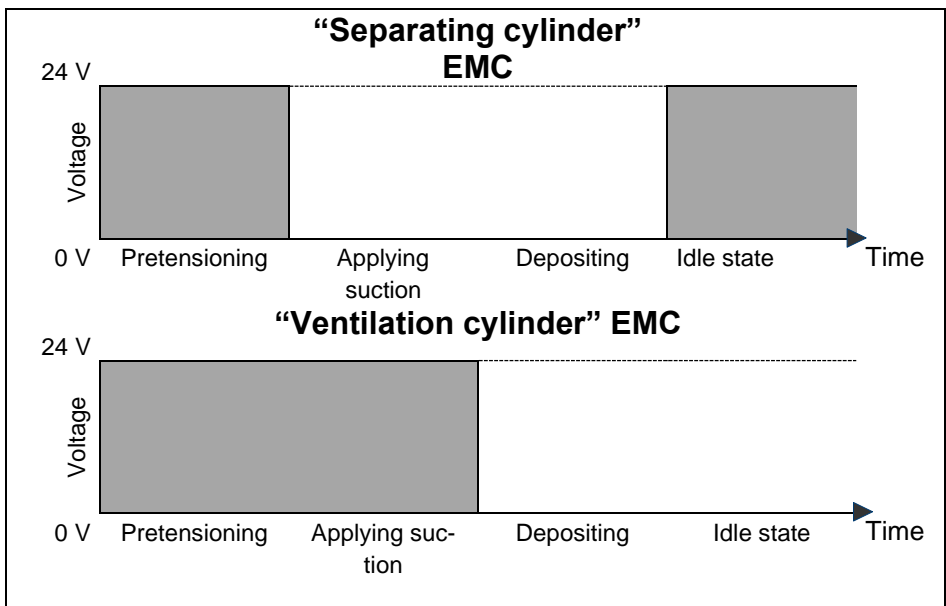

## 6.2.5 Functional Diagram of FMHD with Impulse Valve

Using:

- Separating cylinder
- “Blow off” function
- Impulse valve for controlling the separating cylinder
- NC control valve for the “Blow off” function

At the start of the lifting process, which begins with the preloading from the vacuum reservoir, a brief impulse must be applied to the “Blow off” control valve. This ensures that both valves are in the correct position. An impulse length of 25 ms is sufficient. The impulse length for depositing the workpiece depends on the vacuum level in the gripper and the type of products being handled. The best way to determine it is through tests during the start of operations.



For the impulse valve, an impulse length of 25 ms is sufficient.







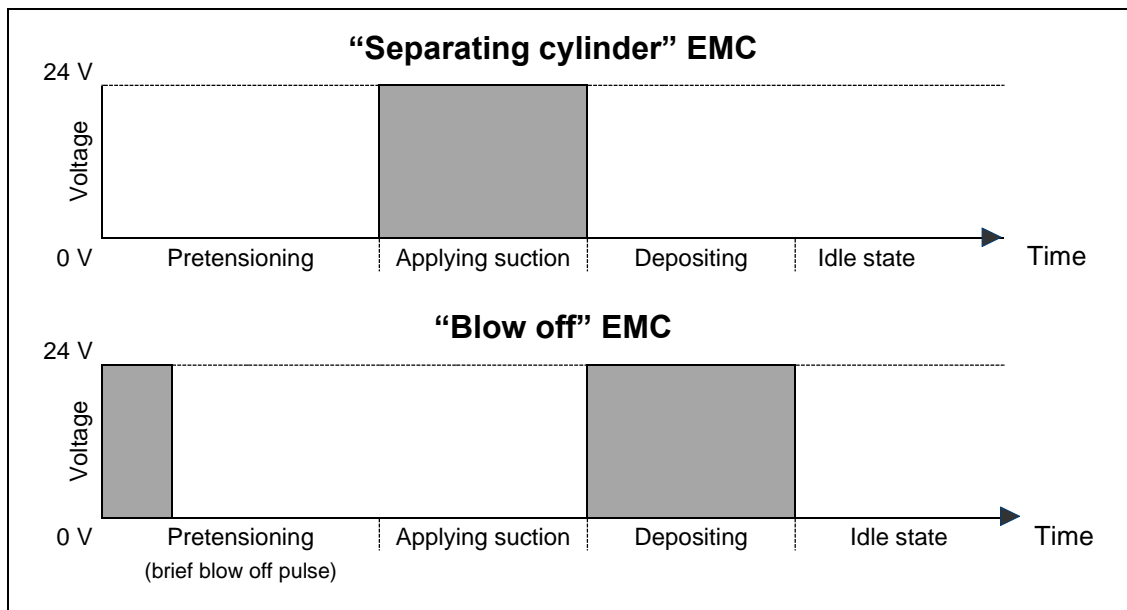





### Duration of the “blow off” compressed air pulse



Depending on the workpiece, the blow off process should last for roughly three to five seconds.



# 7 Troubleshooting

 <b>CAUTION</b>	
	<p><b>General notes on troubleshooting</b></p> <p>Risk of injury</p> <ul style="list-style-type: none"> <li>▶ The system integrator must secure the danger zone.</li> <li>▶ The system may only be operated at the workplace in accordance with the instruction manual.</li> </ul>
	<p><b>Approach of a moving element to a fixed part/machinery mobility/moving elements</b></p> <p>Body parts could be crushed, sucked in or caught if the vacuum area gripper is abruptly attached to a workpiece or a surface or by moving parts.</p> <ul style="list-style-type: none"> <li>▶ Do not place any body parts between the bottom of the gripper and a surface.</li> </ul>
	<p><b>High pressure</b></p> <p>Placement/release of compressed air lines</p> <ul style="list-style-type: none"> <li>▶ The system integrator must secure the danger zone.</li> <li>▶ Regularly inspect the gripper and perform regular maintenance in order to detect and replace porous compressed air lines in good time. Replace defective connectors.</li> </ul>
	<p><b>Stored energy/vacuum</b></p> <p>Body parts could be crushed, cut, sucked in, caught or sliced if the vacuum area gripper is abruptly attached to a workpiece or a surface.</p> <ul style="list-style-type: none"> <li>▶ Do not place any body parts between the bottom of the gripper and a surface.</li> <li>▶ Eyes can be sucked in; do not look into open vacuum openings.</li> </ul>
	<p><b>Conductive parts/parts that have become live in an error state/short circuits</b></p> <p>Electric shock</p> <ul style="list-style-type: none"> <li>▶ Regularly inspect and perform maintenance on the gripper to detect and repair wear or faulty connections in good time.</li> </ul>
	<p><b>Moisture</b></p> <p>Very wet workpieces can permanently impair the function of the gripper</p> <ul style="list-style-type: none"> <li>▶ Only grip dry workpieces if possible</li> <li>▶ Clean the gripper regularly and dry the foam if necessary</li> </ul>

 <b>CAUTION</b>	
 	<p><b>Noise hazards due to the exhaust system or gas flowing at high speeds or worn parts</b></p> <p>Discomfort, tinnitus, stress, exhaustion due to constant/high noise levels</p> <ul style="list-style-type: none"> <li>▶ If possible, switch off vacuum generators and the blow off function when not in use in order to reduce noise pollution.</li> <li>▶ Wear personal protective equipment e.g. ear protectors</li> <li>▶ If possible, position vacuum generators far enough away from machine operation and use additional silencers</li> <li>▶ Regularly inspect and perform maintenance on the system in order to ensure that it works properly.</li> </ul>
	<p><b>Careless use of personal protective equipment</b></p> <p>Danger to the operator</p> <ul style="list-style-type: none"> <li>▶ Adapt and wear appropriate personal protective equipment based on the task performed.</li> </ul>
	<p><b>Dust and fog</b></p> <p>Reduced visibility/difficulty breathing</p> <ul style="list-style-type: none"> <li>▶ Keep the environment clean wherever possible; avoid kicking up large amounts of dust.</li> </ul>

 <b>WARNING</b>	
	<p><b>System operation by untrained personnel</b></p> <p>Serious personal injury</p> <ul style="list-style-type: none"> <li>▶ The system may only be operated by trained personnel who have read and understood the operating instructions.</li> </ul>
	<p><b>Non-compliance with work safety instructions</b></p> <p>Personal injuries and damage to the system</p> <ul style="list-style-type: none"> <li>▶ The device may only be started up in a secure area which no people are allowed to enter.</li> <li>▶ Never lift loads at an angle and never drag them.</li> <li>▶ Do not tear off stuck loads.</li> <li>▶ Only pick up and lift suitable loads (check inherent stability and surface density).</li> <li>▶ Only set workpieces down on clear, even surfaces due to the danger of slipping.</li> <li>▶ Do not release the load until it rests completely and safely on a secure surface.</li> <li>▶ Do not come close to the load when releasing/depositing it and do not touch it.</li> </ul>



<b>Fault</b>	<b>Possible cause</b>	<b>Solution</b>
Vacuum level is not reached or vacuum is created too slowly	Leakage in hose line	Check hose connections
	Leakage or wear on the sealing plates/sealing	Check the sealing plates/sealing and replace if necessary
	The separating or ventilation cylinder does not close correctly.	Check that the seals are okay and whether there are hoses/accumulations of dirt at the opening that prevent the cylinder from sealing the opening.
	The spacer sleeves between the main body and the valve section have been forgotten. The screws to the connection were screwed too tightly.	Reinstall the spacer sleeves. Tighten the screws with the correct tightening torque.
The load cannot be held	Vacuum level too low	See above for possible causes
	Suction force too weak for payload	Increase vacuum or connect additional grippers if necessary
	Check valves are dirty	Clean the valves; to do so, remove the valve plates and masking film
	The area gripper is not pressed firmly enough onto the workpiece to be lifted	Press the area gripper more firmly onto the surface. On even surfaces, we recommend that the foam compress by at least 50%.
	Too short retention time for the area gripper on the workpiece	Extend the retention time
	Too fast or jerky lifting of workpieces	Optimize the motion. Avoid acceleration peaks (especially when lifting the workpieces)
	The workpieces to be lifted are not suitable for the area grippers (e.g. non-rigid).	Use a different gripping system.
	Foam is not glued on correctly, channels form	Peel off the foam and apply cleanly and evenly with a light pull
External vacuum generator works, but workpieces are not picked up	If present: The dust filter of the vacuum generator is dirty	Clean or replace dust filter
	The sealing mat is damaged/torn	Replace sealing mat
	Workpiece is too heavy	Workpiece is not suitable
	The sealing ring of the separating cylinder is damaged	Replace the sealing ring
	The suction bar's slider is clogged with chips or resin	For information on cleaning the sliders and check valves, see Section 9.3
	L x W x H – proportions of the parts to be lifted are not correct	Workpiece is not suitable Minimum workpiece width: 50 mm.
	Vacuum is too high	Determine the maximum possible vacuum of the vacuum generator; check the system for leaks (hose connections, sealing, etc.); valves are dirty; the workpiece is too porous
	The sealing mat is not applied firmly enough	Press the area gripper more firmly onto the surface. On even surfaces, we recommend that the foam compress by at least around 50%.

<b>Fault</b>	<b>Possible cause</b>	<b>Solution</b>
Pneumatic cylinder is not working	Cylinder is defective	Repair cylinder or replace if necessary
	Operating pressure is too low	Set the compressed air supply to 6 bar; check the supply lines (is the hose bent or disconnected?)
	Inspect the solenoid valve	Dirt; defective, control
Solenoid valve is not working	Electrical control is not working	Check the connections and replace valve if necessary
	Solenoid valve is defective	Repair or replace the solenoid valve
Sealing plate wears out very quickly	The vacuum area gripper is angled or makes a grinding noise when applied to the workpiece to be lifted	Set it down vertically on the workpiece
	Material is not optimal	Contact our sales department for advice
Workpieces are no longer deposited	Spring in cylinder is broken, the cylinder no longer retracts	Replace cylinder or spring
	Blow off pulse or ventilation time too short.	Extend the time and check whether the Function is performed.











#### **Recommendation**

We recommend always performing tests with original sample workpieces. We would be happy to help you with testing.

# 8 Maintenance

## 8.1 General Maintenance Instructions

 <b>CAUTION</b>	
 	<p><b>General notes on maintenance</b></p> <p>Risk of injury</p> <ul style="list-style-type: none"> <li>▶ The production system must be stopped in the area where the system is being maintained.</li> <li>▶ The system may only be maintained at the workplace in accordance with the instruction manual.</li> <li>▶ The system must be disconnected and depressurized during maintenance work.</li> <li>▶ The production system must be secured to prevent activation during maintenance work.</li> </ul>
	<p><b>Machinery mobility/moving elements</b></p> <p>Risk of body parts being crushed, pulled in or caught by the moving parts of the gripper</p> <ul style="list-style-type: none"> <li>▶ Take care when operating the gripper and its assemblies when there is a risk of injury (e.g. fingers being crushed by the cylinder/sealing plate)</li> </ul>
 	<p><b>Short-circuit</b></p> <p>Electric shock</p> <ul style="list-style-type: none"> <li>▶ The system must be disconnected during maintenance work.</li> </ul>
	<p><b>Moisture</b></p> <p>Very wet workpieces can permanently impair the function of the gripper</p> <ul style="list-style-type: none"> <li>▶ Regularly clean and, if necessary, dry the gripper</li> </ul>
	<p><b>Careless use of personal protective equipment</b></p> <p>Danger to the operator</p> <ul style="list-style-type: none"> <li>▶ Adapt and wear appropriate personal protective equipment based on the task being performed.</li> </ul>
	<p><b>Dust and fog</b></p> <p>Reduced visibility/difficulty breathing</p> <ul style="list-style-type: none"> <li>▶ Keep the environment clean wherever possible; avoid kicking up large amounts of dust.</li> </ul>
	<p><b>Fumes</b></p> <p>Irritation of the skin and mucous membranes due to cleaning agents</p> <ul style="list-style-type: none"> <li>▶ Observe the safety instructions for using the cleaner in question. Use protective equipment if necessary.</li> </ul>

**WARNING**



**System maintenance by untrained personnel**  
 Serious personal injury

- ▶ The system must only be set up by trained personnel who have read and understood the operating instructions.

**DANGER**



**General safety notes on maintenance**  
 Danger to life and limb

- ▶ The system integrator must secure the danger zone.
- ▶ The production system must be stopped in the area where the system is being maintained.
- ▶ The system may only be maintained in accordance with the operating instructions.
- ▶ The system must be disconnected and depressurized during maintenance.
- ▶ The production system must be secured to prevent activation during maintenance work.

**Human error**  
 Danger to life and limb

- ▶ Adhere to the instruction manual

Remove any dirt on the exterior with a soft cloth and soap suds (max. 60 °C).  
 Operation of the area gripper can draw in dust from the environment. This dust can collect inside the gripper. The gripper must be cleaned regularly, depending on the amount of dust sucked in.

## 8.2 Maintenance Schedule

Maintenance and cleaning may only be carried out by trained specialist personnel or by the manufacturer.

We recommend checking the contamination within the suction bar for the first time in the first month after start of operations.

	Interval				
	Daily	Weekly	Monthly	Every six months	Annual inspection
Does the vacuum generator make strange noises when a full load is picked up?		X			
Has the dust filter been cleaned?		X			
Is the electrical installation still okay? Is the cable screw union secure?				X	
Are the vacuum hoses in good condition (not brittle, not kinked, no worn sections and no leaks)?			X		
Check that all the connections are secure, e.g. the screws, hose clamps, etc.				X	
Are the type plate and maximum load plate still attached to the device?					X

Are the operating instructions available and are the system operators familiar with them?					X
Check all load-bearing parts (e.g. suspension eyes) for deformation, wear, or other damage.			X		
Check the sealing mats for wear, tears and leaks. Replace if necessary.		X			
General condition of the device					X
Leak test			X		
Check reservoir/suction chamber and ball valves for dirt	The interval depends on the application/ambient conditions.				

### 8.3 External Vacuum Generator

See the relevant operating instructions.

### 8.4 Dust Filter

When using a dust filter, see the relevant operating instructions.

### 8.5 Cleaning Agents

Use cleaning solvents to clean the device (not petroleum ether or corrosive liquids. Petroleum ether or corrosive liquids destroy the vacuum hoses).

### 8.6 Quick-change Plate

To make maintenance easier and replace the foam more quickly, the quick-change plate is integrated into the gripper as standard. In order to reduce downtime, a second, identical plate can be made available during maintenance and used to replace the contaminated plate. See Section 9.9



## 8.7 Valve Plate

For enhanced maintenance, the valve plate can be unscrewed and removed. This is where the valves are located. For cleaning purposes, the attached masking films can be removed so that the balls can be removed. In order to ensure that the vacuum area gripper continues to work optimally, the valves must be cleaned regularly, especially when exposed to resins. We recommend replacing the old masking film with a new masking film during cleaning. If necessary, heavily contaminated balls can also be replaced. The operator also has the option to make a second, identical plate available for replacement during maintenance.

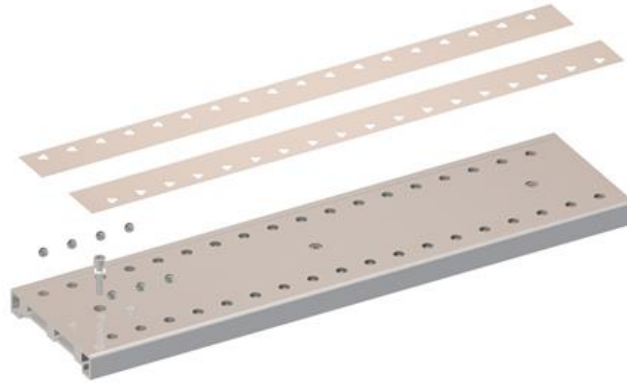

## 8.8 Sealing Plate

Check the sealing plates for wear, tears and leakage on a regular basis and replace them as necessary. The sealing plates must also be replaced if you notice that the vacuum is constantly dropping when handling the same parts.

Minimum recommended vacuum: 250 mbar when a workpiece is picked up.

For systems that are designed to require higher vacuum, the minimum vacuum must be adjusted accordingly when the sealing plates are replaced.



The foam may not be cleaned with a compressed-air gun. This would make the foam permeable to air in the places where compressed air was applied.

If the sealing plate shows mechanical damage, it can be repaired up to a certain point using standard vulcanizing adhesive (e.g. adhesive for repairing the inner tubes of bicycles).

### Replacing the sealing plates

- In order to easily replace the sealing plates, the quick-change plate can be removed in accordance with the operating instructions. This means that it is not necessary to replace the sealing plate overhead.
- Remove the sealing plate from the quick-change system.
- Clean the surfaces. In order to maintain optimal hold of the new sealing plate, the surface must be free of dust, oil, oxides and adhesive residues.
- Remove the protective film from the adhesive strip of the new sealing plate.
- Press the sealing plate firmly onto the entire surface without any wrinkles (e.g. with a roller).
- The openings of the sealing plate and valves must be aligned.
- Processing temperature: a range of +10° C to +40° C is recommended for the object temperature and the ambient temperature.

Video



[www.schmalz.com/  
replacing-sealing-  
foam](http://www.schmalz.com/replacing-sealing-foam)



The sealing mat is asymmetrical. Make sure that it is correctly aligned.

## 8.9 Inspecting and Cleaning the Gripper

The gripper must be inspected and maintained regularly in order to ensure that it works optimally. For instructions on how to do so, see Section 8.1 General Maintenance Instructions.

**Switch the compressed air, electricity and vacuum generator off in advance.**

1. Check the cable and hose connections. Check for damaged areas, leakage, ensure that the screw unions are tight and that no screws are missing, etc.
2. Check that the attachment parts such as the housing cover, cylinder mounting plate and quick-release clamp are secured correctly. Check that the quick-release clamps are securely attached, intact, and easy to operate.
3. Open the quick-release clamp and remove the quick-change plate. The suspension device must be clean. For information on inspecting and replacing the sealing plate if necessary, see Section 8.8. The quick-change section can be blown off with compressed air as a single component (without the sealing plate) or cleaned with the cleaning agent described above.

Video



[www.schmalz.com/cleaning-the-fmhd](http://www.schmalz.com/cleaning-the-fmhd)

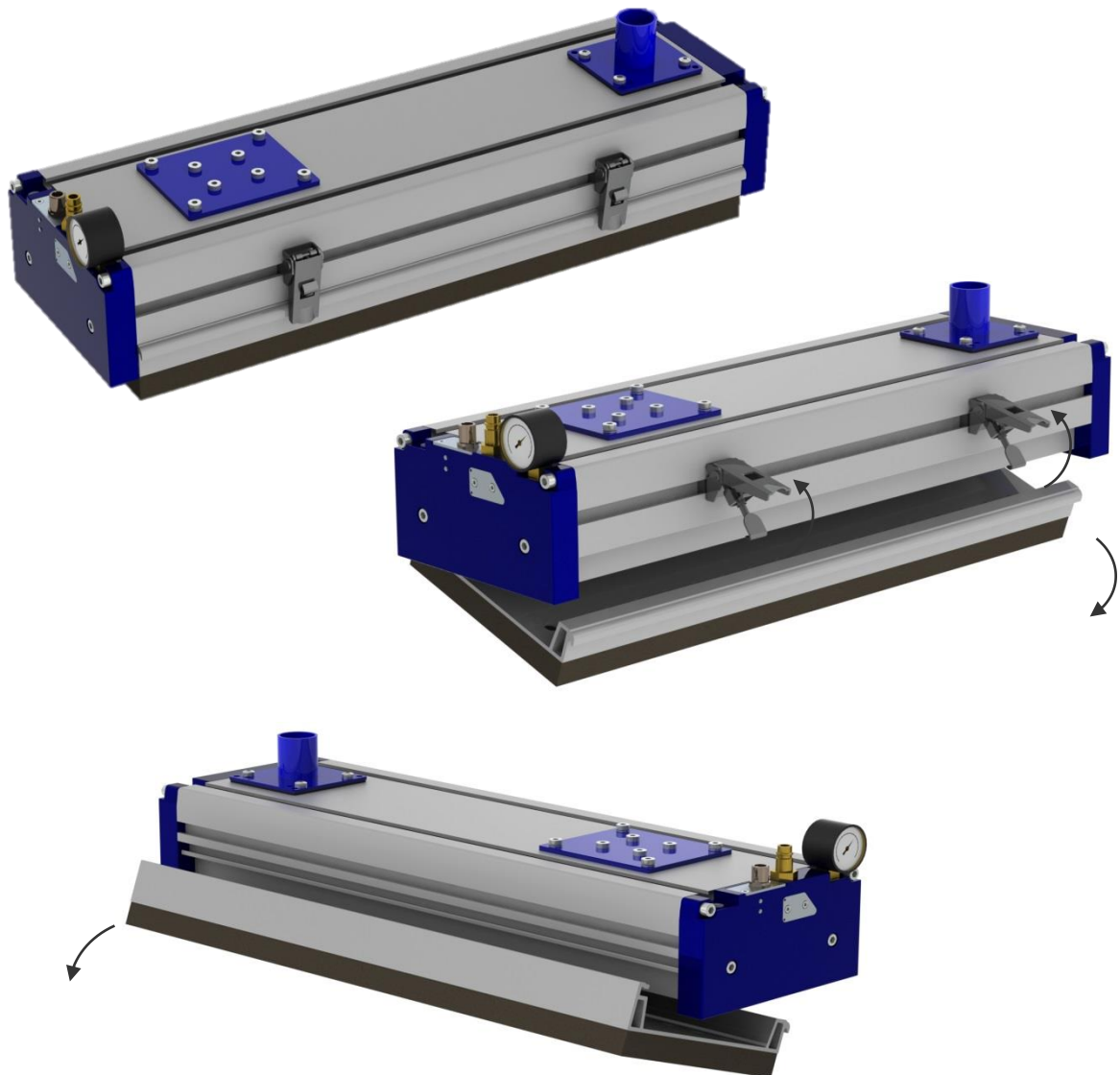

4. If it is heavily contaminated, the **valve plate** must be also cleaned. To do so, first unscrew the screws in the end covers (A+F) by a few millimeters so that the valve plate and the sealing does not damage the front sealing when you remove the valve plate.
5. Next, unscrew the screws of the valve plate (5). Start with the outer screws. The screws are secured against falling out with small sleeves (item no. 16 on the spare parts list). Ensure that the valve plate does not fall during disassembly.

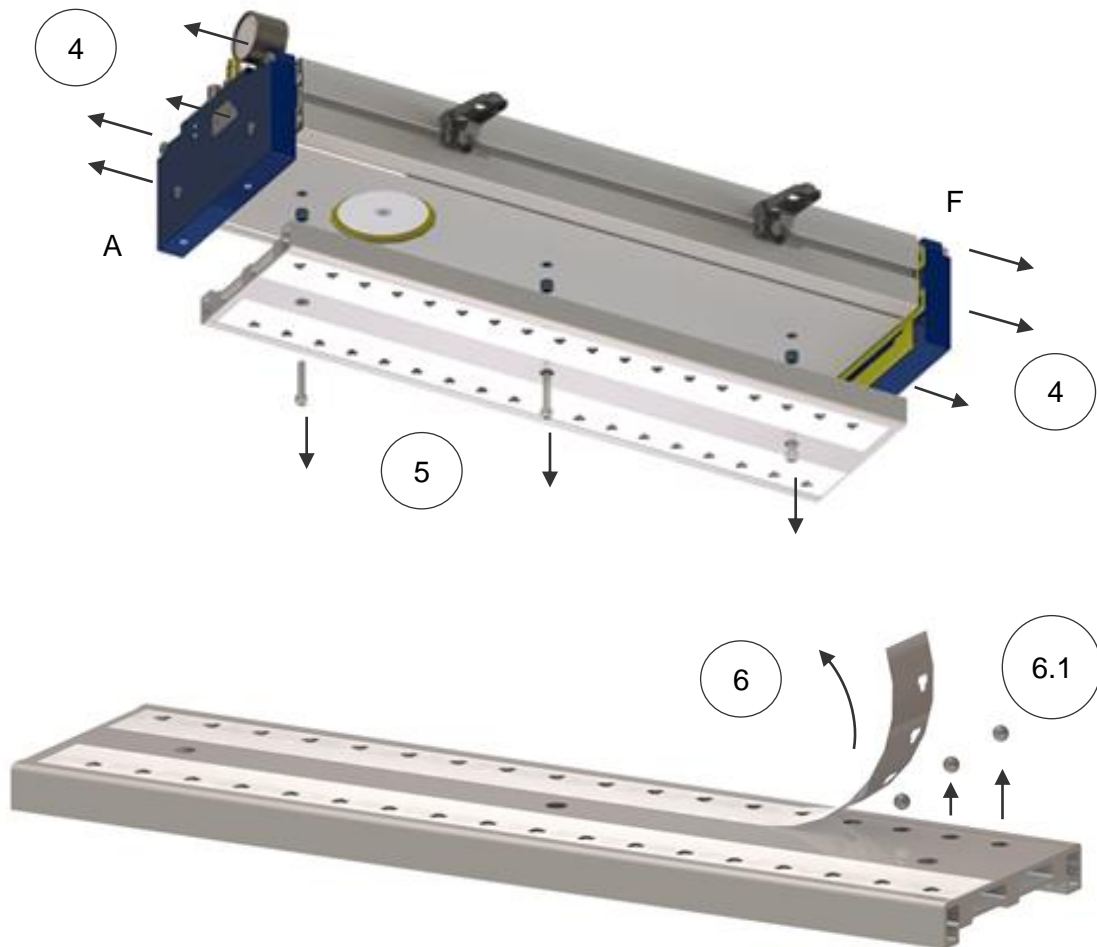

6. To clean the valves, carry out the following steps:
  - Remove the adhered masking film (H).
  - If the masking film is still in very good condition, it can be reused – the adhesive surface must be protected against dust/moisture.
  - Remove the balls, e.g. using a magnet (6.1).
  - Soak the contaminated balls in a soap/detergent solution.
  - Blow out the valve section (G)/valves (without sliders) with compressed air or, if necessary, clean them with solvents (soak if necessary).
  - Dry all of the parts.
  - Insert the sliders/balls back into the valves. Insert one slider into each valve to ensure that the valves work properly.
  - Reattach the masking film. Ensure that the openings of the clover shapes align with the valves.
  - Clean the base section if necessary (see point 7).
  - Note the asymmetry of the valve plate and screw it back on to the base section (D). To assemble the parts, carry out the steps for disassembly in the reverse order. Tightening torque of the screws: 10 Nm. The base and valve profiles must be flush to one another and may not be shifted relative to one another.
  - In the final step, screw the end cover on tightly, suspend the quick-change section and clamp it tightly. Tightening torque of the screws: 10 Nm.



7. To inspect the contamination level in the **base section**, completely remove the end cover. You can blow out the gripper with compressed air. When removing the functional cover, ensure that the hose connection to the separating cylinder is disconnected.
8. You can easily remove the separating cylinder assembly to check its condition. To do this, proceed as follows:
  - Unscrew the four outer fastening screws on the cylinder mounting plate.
  - Remove the mounting plate and cylinder from the system; when doing so, disconnect the connecting hose for the functional cover
  - Inspect the hoses, quick exhaust valve and T section and blow them out with compressed air if necessary.
  - Check the cylinder. This is fully retracted when depressurized. When you pull on the sealing plate, you can notice significant resistance. After you release it, the cylinder immediately moves back to its starting position. If not, the cylinder must be replaced.
  - Check the sealing. Replace defective sealings. Remove adhesive residues and any other contamination when doing so. The adhesive surfaces must be kept clean and dry before the new sealing can be attached.
  - Reinstall the cylinder, connect it to the pneumatic hose and quick-change valve, and reattach the mounting plate. Ensure that the pneumatic hose is not bent or positioned in a way that would impair the function of the separating cylinder.
  - Afterwards, perform a leak test.

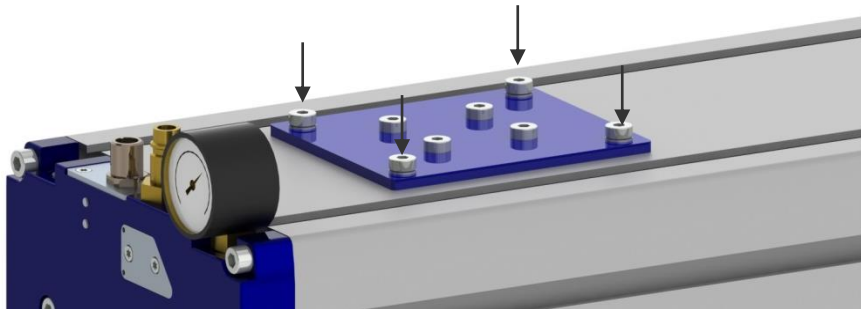

### Connecting the separating cylinder

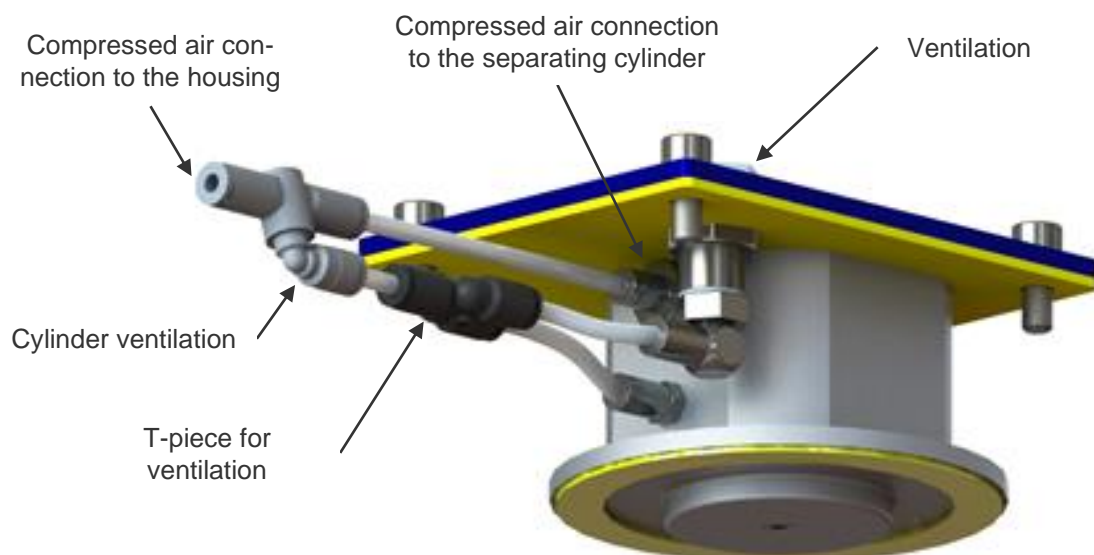

### Checking the ventilation cylinder (not used as standard):

To check the condition of the ventilation cylinders, you must remove the quick-change plate and valve plate. You can access the ventilation cylinder from the bottom of the base section.

- Unscrew the four fastening screws of the cylinder mounting plate.
- Remove the mounting plate from the system together with the cylinder. Pay attention to the hoses.
- Perform additional steps in the same way as checking and cleaning the separating cylinder

### Connecting the ventilation cylinder

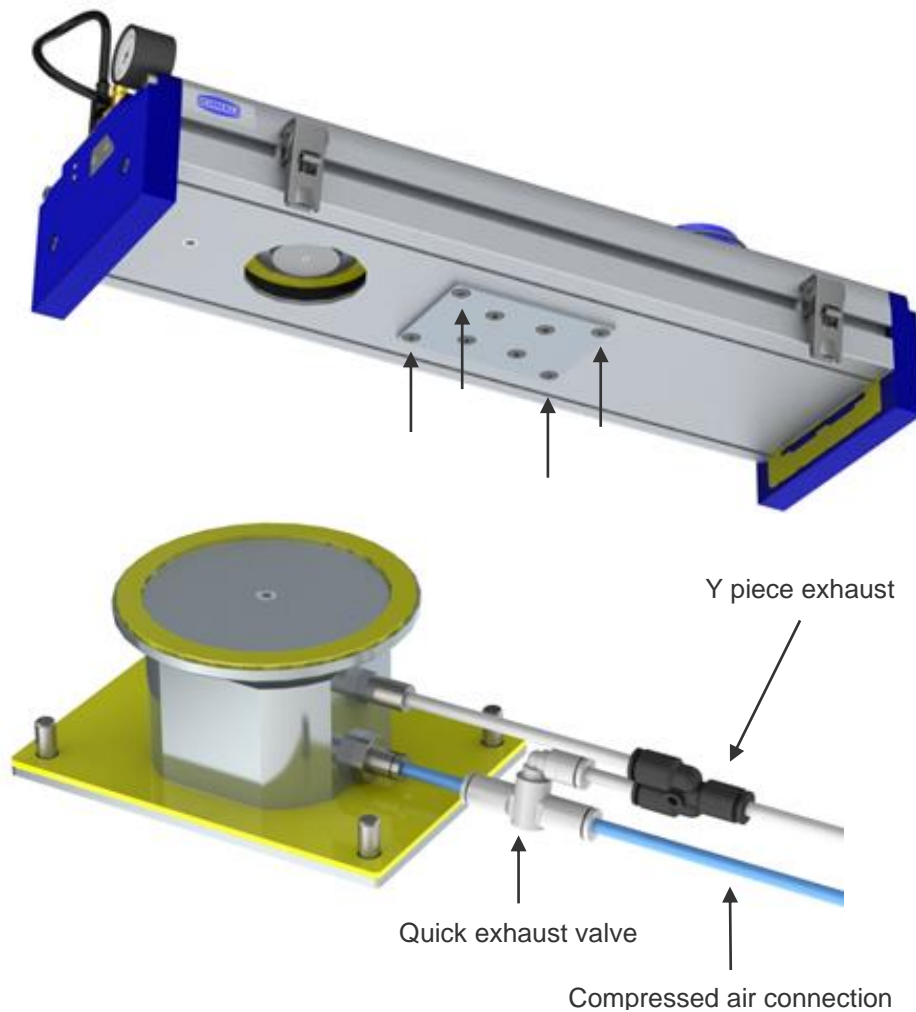

## 8.10 Overview of the Tightening Torque of the Screws

Screw designation	Size	Torque
Housing cover screws	M6x30 steel	9.8 Nm
Valve plate screws	M6x30 stainless steel	9.8 Nm
Fastening screws for separator cylinder assembly	M6x16 steel	9.8 Nm

## 8.11 Checking the System for Leaks

The vacuum area gripper must be ready for operation in order to check the system for leaks. Close the separating cylinder and switch on the vacuum generator. The vacuum level can now be read at the gauge. The measured value should be up to 10% lower than the maximum vacuum level of the vacuum generator used.

Example: The vacuum generator reaches a maximum of  $-0.5$  bar → A vacuum of at least  $-0.45$  bar must be displayed on the gauge.

If the vacuum is not achieved, the system must be checked for leakage as follows.

1. Check the hose, hose connections, tubing and the cable screw union on the multi-pole plug for damage and leaks, and replace them as necessary.
2. Check that all the sections and all other functional components are properly assembled.
3. Check that the spacer sleeves are still in place between the valve plate and base section.
4. Check whether the vacuum filter is blocked or dirty; if necessary, clean the filter cartridge or replace it.
5. Check the seals on the covers and separating cylinder and replace if necessary.
6. Check that the vacuum generator is fully functional.

# 9 Spare and Wearing Parts

We guarantee this device pursuant to our General Terms and Conditions of Sale and Delivery. The same applies to spare parts, provided that these are original parts supplied by us. We are not liable for any damage resulting from the use of non-original spare parts or accessories. Wearing parts are not covered by the warranty.

<b>ATTENTION</b>	
	<p><b>Incorrect disposal of the system or individual components</b></p> <p>Environmental damage</p> <p>► Disposal according to national guidelines.</p>

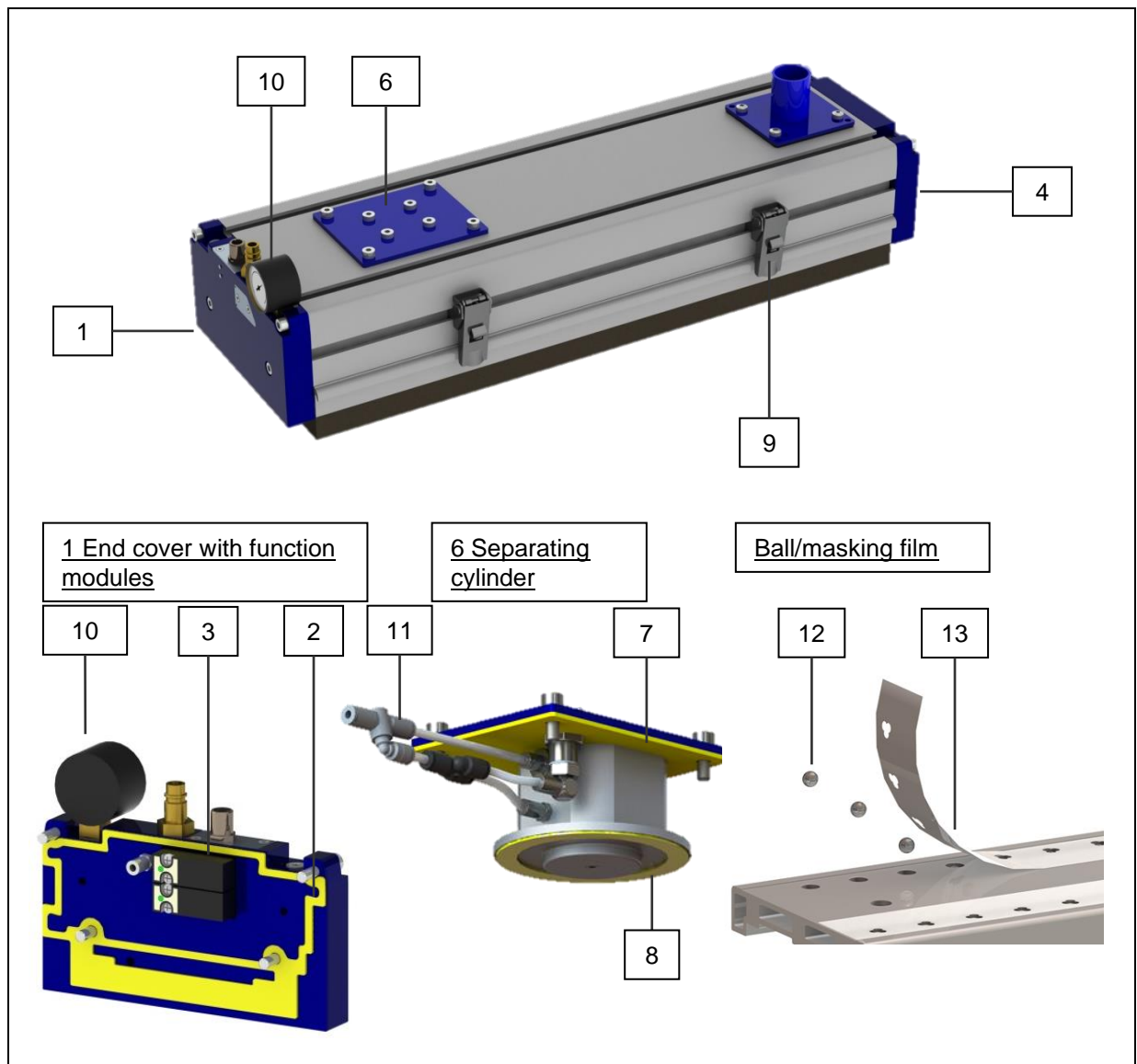

Item	Quantity	Description	Part no.	Legend
1	1	Housing cover (assembled) – PNP standard version with 2x NC control valves (for separating cylinder and blow off)	10.01.40.00021	S
1	1	Housing cover (assembled) - PNP version with impulse valve for separating cylinder & blow off	10.01.40.00754	S

1	1	Housing cover (assembled) – PNP version for separating cylinder & ventilation cylinder	10.01.40.00865	S
2	1	Form seal (suitable for item 1)	10.01.40.00013	W
3	1	Solenoid valve 3/2 NC – used on standard version	10.05.01.00277	S
3	1	Solenoid valve 3/2 - impulse valve (used for “separating cylinder” function on customer-specific grippers)		
3**	1	Form seal for the protective cap	10.01.40.00080	W
4	1	Housing cover (assembled) – without function modules	10.01.40.00024	S
4**	1	Housing cover (assembled) – with G1¼ bore for ejector connection	10.01.40.00752	S
5**	1	Form seal (suitable for item 4)	10.01.40.00014	W
6	1	Separating cylinder (assembled)	10.01.40.00161	S
**	1	Ventilation cylinder (assembled)	10.01.40.00800	S
7	1	Form seal for separating cylinder (91x117x2 mm)	10.01.40.00150	W
**	1	Form seal for ventilation cylinder, 120x84x2 mm	10.01.40.00797	W
8	1	Form seal for separating cylinder sealing plate Ø 88 mm	10.01.40.00017	W
**	1	Form seal for ventilation cylinder sealing plate Ø 82.6 mm	10.01.40.00799	W
9	*	Mounting kit (quick-release clamp including attachment)	10.01.40.00023	S
10	1	Analog vacuum gauge	10.01.40.00094	S
11	1	Quick exhaust valve	10.05.03.00321	S
12	*	Stainless-steel bearing	10.01.40.00102	S
13	1	Masking film (length: 3,000 mm, cut to size)	10.01.40.00108	W
14**	*	Sealing ring M6	10.07.08.00017	W
15**	*	Cylinder connection hose	On request	S
16**	*	Spacing sleeve with thread locking compound	10.01.40.00151	W

\* Quantity depends on the length of the vacuum area gripper

\*\* Items not shown

**S**= Spare part, **W**= Wearing part

## Configurable spare part assemblies

To order a spare part assembly, keep the product key of your flat suction cup at hand. Item 24 (sealing plate) can be individually adapted to your application at any time. To do so, please contact our Technical Sales department.

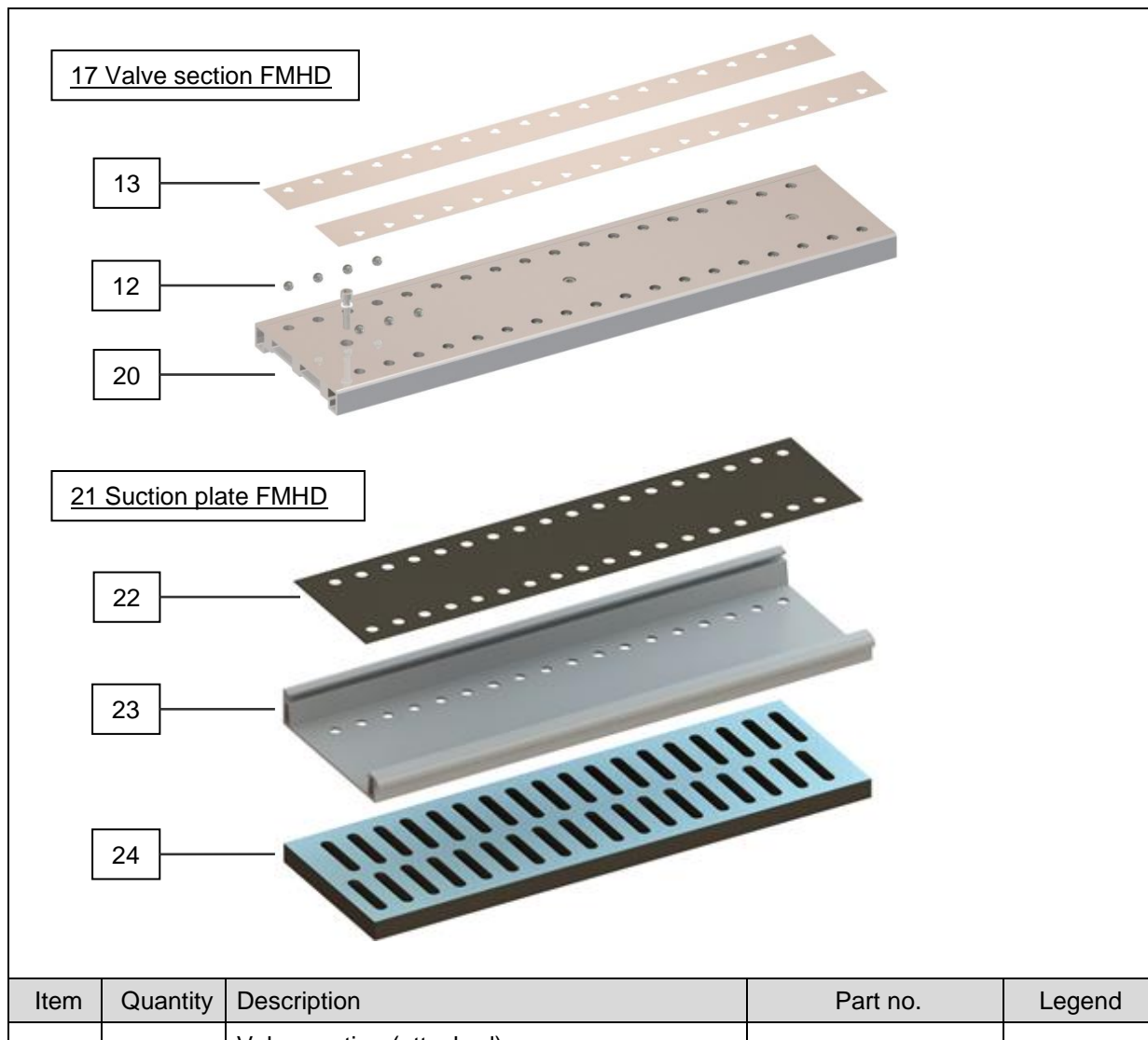

Item	Quantity	Description	Part no.	Legend
17	1	Valve section (attached) comprised of items 18–20 (including mounting materials)	On request	S
13	1	Masking film (length: 3,000 mm, cut to size)	10.01.40.00108	W
12	*	Stainless-steel bearing	10.01.40.00102	S
20	1	Gripper section FMHD -M-	On request	S
21	1	Area gripper suction plate comprised of items 22–24	On request	S
22	1	Sealing plate (O04)	On request	W
23	1	Gripper section FMHD -U-	On request	S
24	1	Sealing plate	On request	W

\* Quantity depends on the length of the vacuum area gripper  
S= Spare part, W= Wearing part

# 10 Accessories

## Rigid suspension FST STARR

Item	Description	Part no.
1	FST-STARR 25-2 (spring plunger, 25mm stroke)	10.01.10.07012
1	FST-STARR 50-2 (spring plunger, 50mm stroke)	10.01.10.07013
1	FST-STARR 75-2 (spring plunger, 75mm stroke)	10.01.10.07014
2	FLK G1/2-IG G1/2-AG (Flexolink)	10.01.03.00175
2	FLK G1/2-IG G1/2-AG V (Flexolink, reinforced design)	10.01.03.00207
3	FLAN-PL	10.01.10.08805

We recommend connecting the gripper to a combination of FST-STARR and FST FLEX (fixed and floating bearings).

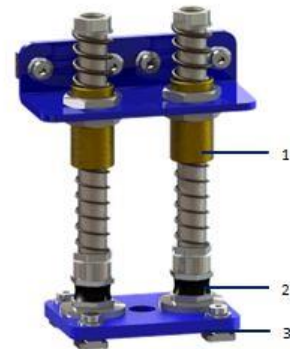

## Rigid suspension FST-FLEX

Item	Description	Part no.
1	FST-FLEX 25-2 (spring plunger, 25 mm stroke)	10.01.10.07018
1	FST-FLEX 50-2 (spring plunger, 50 mm stroke)	10.01.10.07019
1	FST-FLEX 75-2 (spring plunger, 75 mm stroke)	10.01.10.07020
2	FLK G1/2-IG G1/2-AG (Flexolink)	10.01.03.00175
2	FLK G1/2-IG G1/2-AG V (Flexolink, reinforced design)	10.01.03.00207
3	FLAN-PL	10.01.10.08805

We recommend connecting the gripper to a combination of FST-STARR and FST FLEX (fixed and floating bearings).

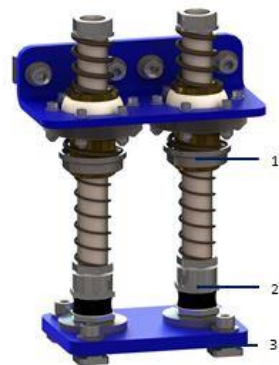

## Rigid suspension FST-C

Item	Description	Part no.
1	FST-C 100-HD1 (100 mm stroke)	10.01.20.01260
2*	MOD-FLAN 157x120x64.1	10.01.11.03187

\* Similar to the figure

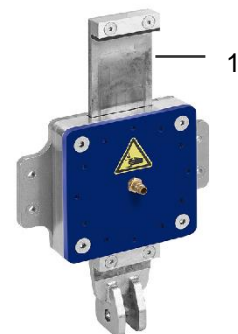

## Vacuum distributor

Item	Description	Part no.
1	Vacuum distributor with three hose connectors (hose internal diameter: 60 mm)	10.01.10.02779
2	Vacuum distributor with four hose connectors (hose internal diameter: 60 mm)	10.01.10.03196
*	Vacuum distributor with five hose connectors (hose internal diameter: 60 mm)	10.01.10.03066

\* Without blow off module

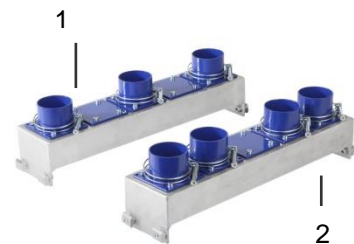

## Additional accessories

Item	Description	Part no.
1	VSi V D M12-4 (vacuum switch)	10.06.02.00580
2	ASK B-M12-4 (connection cable for VSi)	21.04.05.00263
*	ASK B-M12-5 (connection cable for FMHD)	21.04.05.00080
3	Vacuum switch (installed) see figure/incl. items 1 & 2 (vacuum switch and connection cable)	10.01.22.04338
*	Sliding block (VSi attachment mounted)	10.01.21.04651

\*Not shown

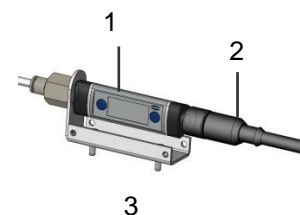

# 11 Pneumatic Circuit Diagram

Before initiating the blow off pulse, ensure that the gripper (with attached workpiece) is not pressed against a solid surface. The workpiece must be able to freely detach from the gripper.



## Maximum overpressure

The maximum overpressure in the gripper (vacuum reservoir or valve chamber) must be limited to a maximum of 0.2 bar.

## 11.1 Pneumatic Circuit Diagram of the Standard Version FMHD

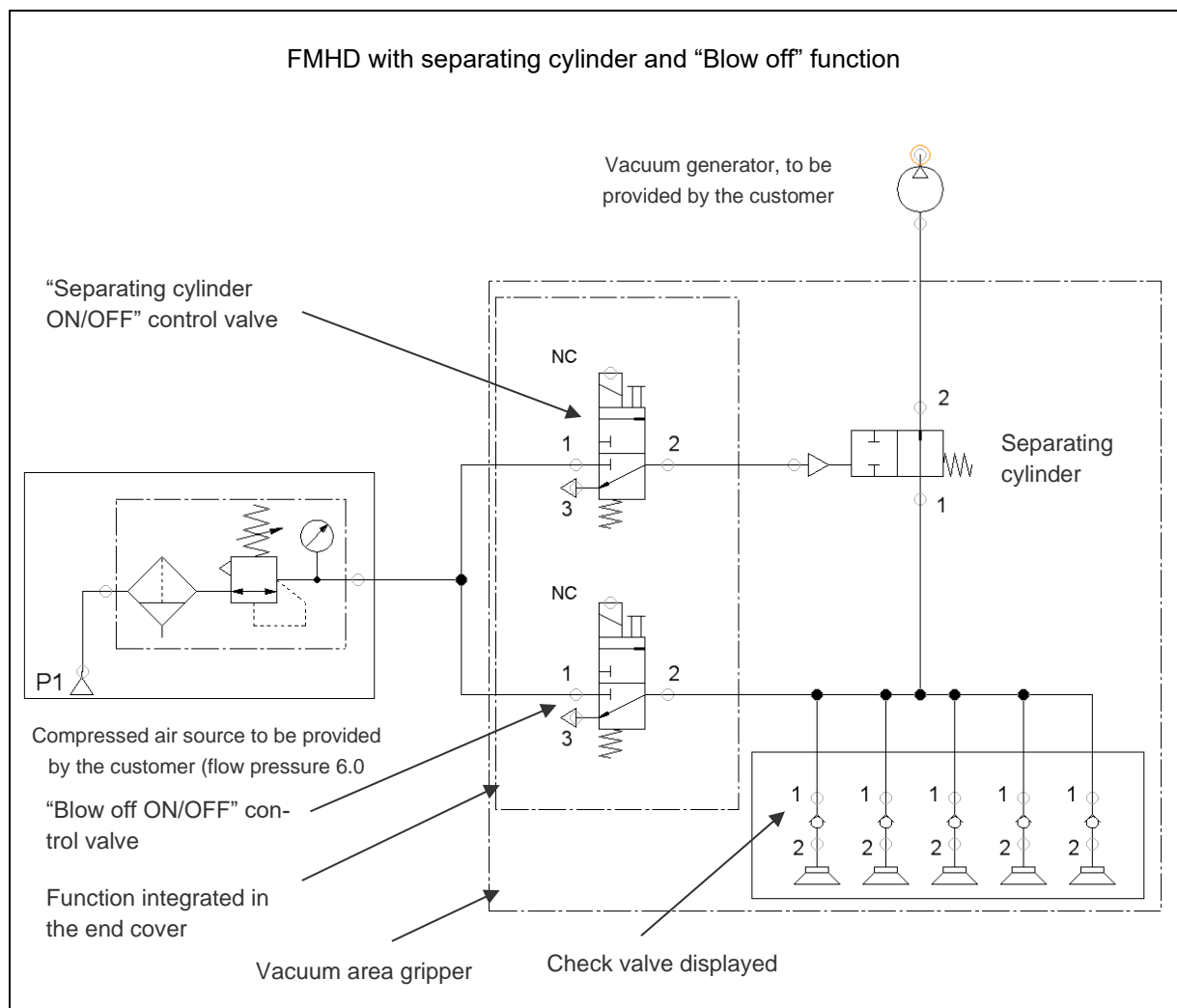



# 11.2 Pneumatic Circuit Diagram of the FMHD with Ventilation Cylinder

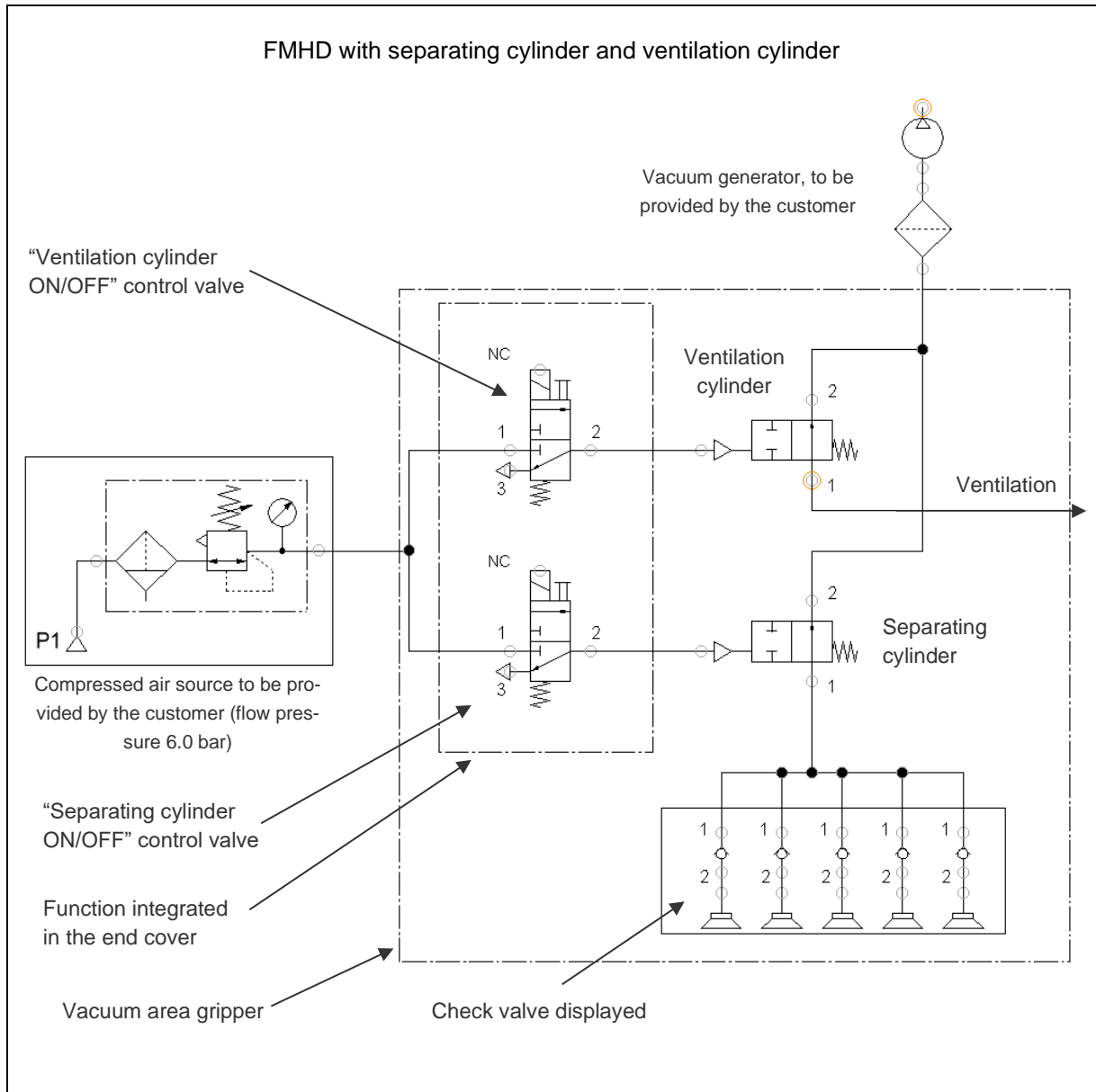

# 11.3 Pneumatic Circuit Diagram of the FMHD with Impulse Valve

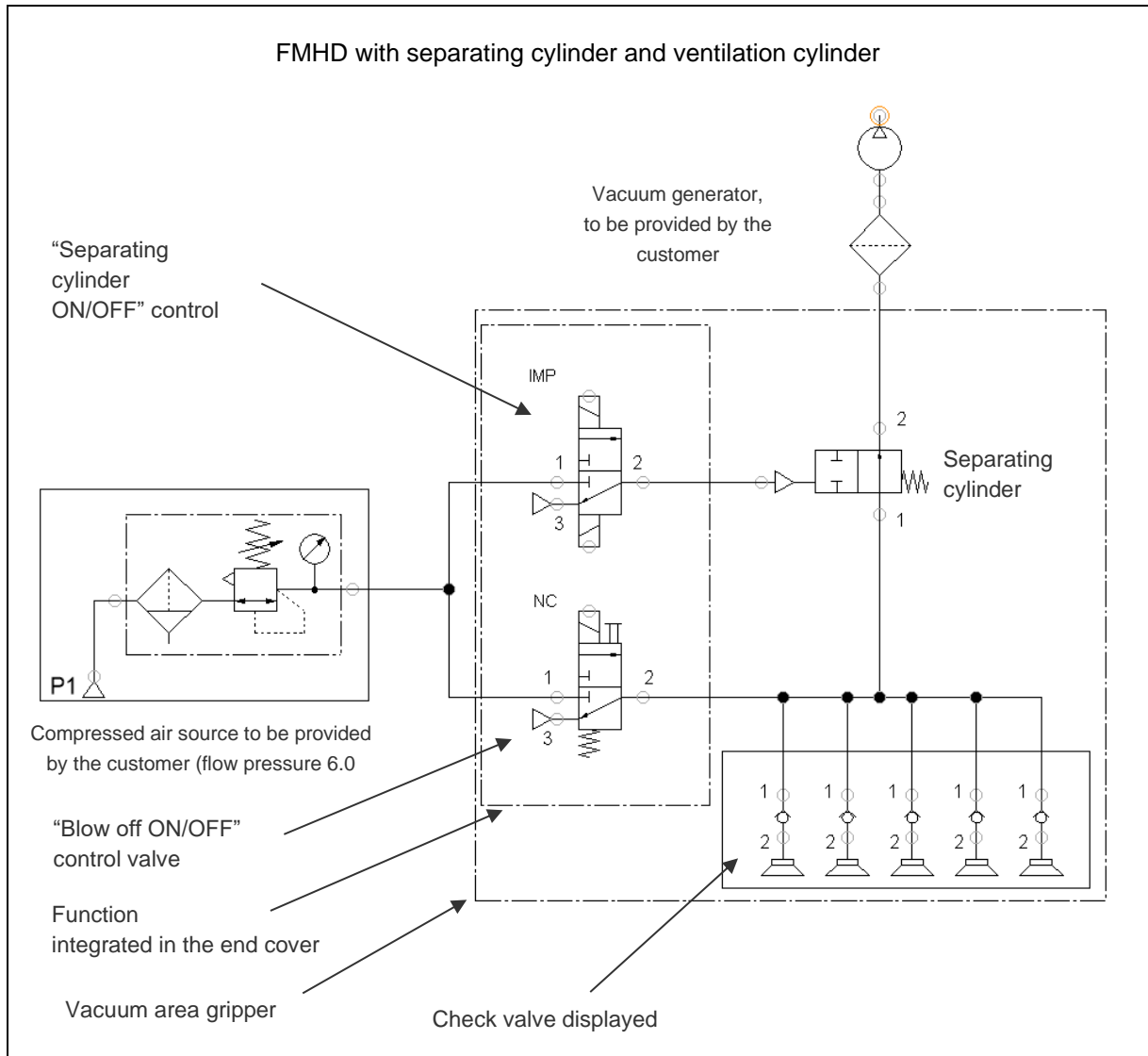

## 11.4 Pneumatic Circuit Diagram of the FMHD – Parallel Circuit

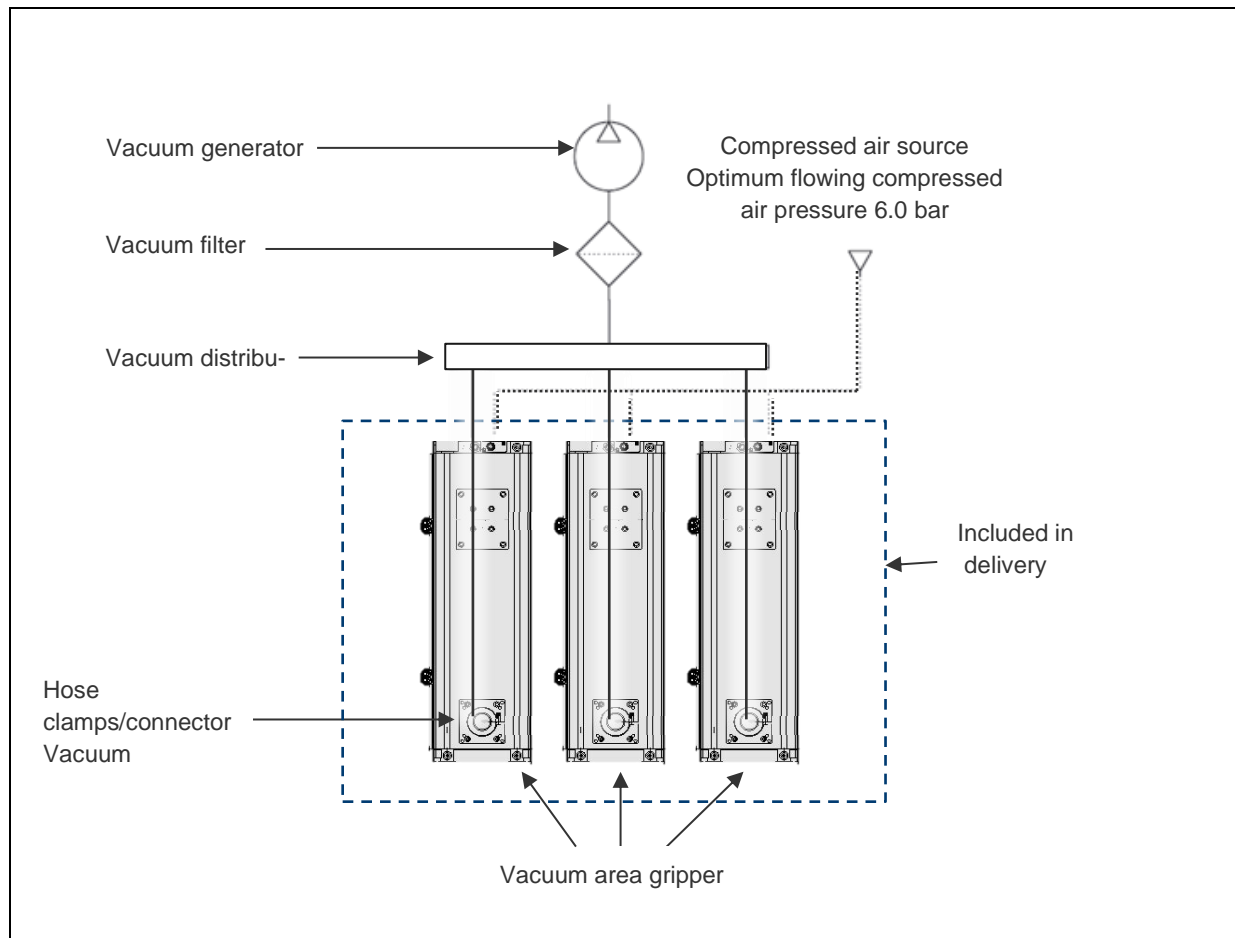

## 12 Other Applicable Documents

EC declaration of incorporation FMHD  
Product Declaration of Conformity

30.30.01.01665  
30.30.01.02574

### For versions with ejector and dust filter

Ejector instruction manual  
Dust filter instruction manual

30.30.01.01005  
30.30.01.00059

## The Schmalz Group – Worldwide On Site



 Germany – Glatten

 International companies:

Australia – Melbourne  
 Austria – Pasching  
 Benelux – Hengelo (NL)  
 Canada – Mississauga  
 China – Shanghai  
 China – Taicang  
 Czech Republic – Hranice  
 Finland – Vantaa  
 France – Champs-sur-Marne  
 India – Pune  
 Italy – Galliate (NO)

 Sales partners

Japan – Yokohama  
 Mexico – Querétaro  
 Poland – Komorniki (Poznan)  
 Russia – Moscow  
 South Korea – Anyang  
 Spain – Erandio (Vizcaya)  
 Switzerland – Nürensdorf  
 Turkey – Istanbul  
 United Kingdom – Manchester  
 USA – Raleigh (NC)

**BINAR HANDLING**

 Sweden – Trollhättan

 International companies:

China – Shanghai  
 France – La Haie-Fouassière  
 Germany – Staufenberg  
 Turkey – Ataşehir-Istanbul

 Palamatic

 United Kingdom – Chesterfield

**GPS** ANWENDUNGSTECHNIK

 Germany – Stuttgart

### Vacuum Automation

[WWW.SCHMALZ.COM/AUTOMATION](http://WWW.SCHMALZ.COM/AUTOMATION)

### Handling Systems

[WWW.SCHMALZ.COM/HANDLING-SYSTEMS](http://WWW.SCHMALZ.COM/HANDLING-SYSTEMS)

J. Schmalz GmbH

Johannes-Schmalz-Str. 1  
 72293 Glatten, Germany  
 T: +49 7443 2403-0  
 schmalz@schmalz.de  
 WWW.SCHMALZ.COM



schmalz.vacuumtechnology



schmalz\_group



schmalzmediacenter



schmalz



j-schmalzgmbh



schmalz\_de