

Flat Suction Cups PFYN

Suction area (\varnothing) from 1 mm to 200 mm

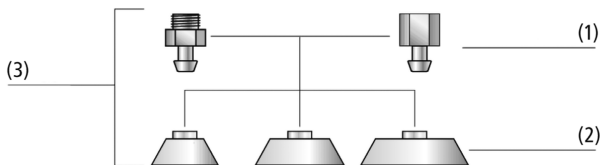

Flat Suction Cups PFYN



System design Flat Suction Cups PFYN

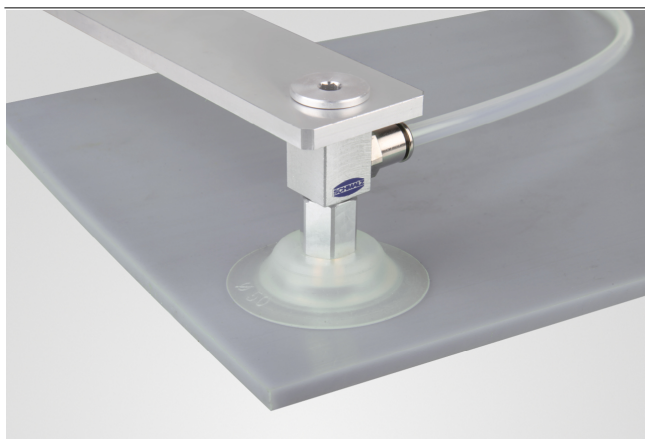

Flat suction cups PFYN being used for handling plastic boards

Suitability for industry specific applications

Applications

- Round, flat suction cup for handling of flat workpieces with smooth or slightly rough surfaces
- Handling of hot workpieces (HT1, SI, FPM)
- Low marking and antistatic handling of sensitive workpieces (HT1 and AS versions)

Design

- Robust, wear-resistant suction cup PFYN (3) with single sealing lip, consisting of suction cup PFG (2) and connection nipple (1)
- Nipple plugged in on cups up to 50 mm in diameter
- Nipple screwed into a metal inlay (vulcanized to the cup) on cups with a diameter of 60 mm or more
- With each nipple family, the replacement cups and nipples can be combined as desired

Product highlights

- Large selection of materials meets a wide range of requirements (temperature-resistant, antistatic, non-marking, chemical resistance)
- Wide range of diameters for a large selection of different workpieces
- High suction force with small dimensions
- Fastest cycle times thanks to low own volume
- Support surfaces on the bottom prevent permanent deformation of thin-walled workpieces

Flat Suction Cups PFYN

Suction area (Ø) from 1 mm to 200 mm

Designation code Flat Suction Cups PFYN

PFYN	–	20	–	NBR-55	–	G1/8-AG
1		2		3		4

1 – Abbreviated designation

Code	Version
PFYN	Flat

2 – Suction area

Code	Diameter in mm
1...200	ø 1 to 200

3 – Material

Code	Material
FPM-65	Fluorcaoutchuc
HT1-60	High temperature material
NBR-55	Nitrile caoutchuc
NBR-AS-55	Nitrile caoutchuc
PU-55	Polyurethane
SI-55	Silicone
SI-AS-55	Silicone

4 – Connection

Code	Connection
M3-AG	M3-AG (AG = male (M))
M5-AG	M5-AG
M5-IG	M5-IG (IG = female (F))
G1/8-AG	G1/8-AG
G1/8-IG	G1/8-IG
G1/4-AG	G1/4-AG
G1/4-IG	G1/4-IG
G1/2-IG	G1/2-IG

Suction cup PFYN (elastomer part + connection nipple) is delivered unassembled (diameters of 120 mm and more are assembled).
The delivery consists of:

- Suction cup of type PFG – elastomer part, available in various diameters and materials
- Connection nipple of type SA-NIP – available with various threads

Available spare parts: suction cup PFG, connection nipple SA-NIP

Flat Suction Cups PFYN

Suction area (Ø) from 1 mm to 200 mm

Ordering data Flat Suction Cups PFYN

Type			Suction cup material with ShA: *						
			FPM-65	HT1-60	NBR-55	NBR-CO-55	PU-55	SI-55	SI-CO-55
PFYN	1.0	M3-AG	-	-	10.01.01.00274	10.01.01.10375	-	10.01.01.00280	-
PFYN	1.5	M3-AG	-	-	10.01.01.00275	10.01.01.10376	-	10.01.01.00281	-
PFYN	2.0	M3-AG	-	10.01.01.13000	10.01.01.00276	10.01.01.10377	-	10.01.01.00282	10.01.01.10391
PFYN	3.5	M3-AG	10.01.01.00295	10.01.01.12982	10.01.01.00277	10.01.01.10378	-	10.01.01.00283	10.01.01.10392
PFYN	5.0	M5-AG	10.01.01.00179	10.01.01.11130	10.01.01.00137	10.01.01.10379	-	10.01.01.00151	10.01.01.10393
PFYN	5.0	M5-IG	10.01.01.00123	10.01.01.11144	10.01.01.00081	10.01.01.10345	-	10.01.01.00095	10.01.01.10357
PFYN	6.0	M5-AG	10.01.01.00180	10.01.01.11131	10.01.01.00138	10.01.01.10380	-	10.01.01.00152	10.01.01.10394
PFYN	6.0	M5-IG	10.01.01.00124	10.01.01.11145	10.01.01.00082	10.01.01.10346	-	10.01.01.00096	10.01.01.10358
PFYN	8.0	M5-AG	10.01.01.00181	10.01.01.11132	10.01.01.00139	10.01.01.10381	10.01.01.00167	10.01.01.00153	10.01.01.10395
PFYN	8.0	M5-IG	10.01.01.00125	10.01.01.11146	10.01.01.00083	10.01.01.10347	10.01.01.00111	10.01.01.00097	10.01.01.10359
PFYN	10.0	M5-AG	10.01.01.00182	10.01.01.11133	10.01.01.00140	10.01.01.10382	10.01.01.00168	10.01.01.00154	10.01.01.10396
PFYN	10.0	M5-IG	10.01.01.00126	10.01.01.11147	10.01.01.00084	10.01.01.10348	10.01.01.00112	10.01.01.00098	10.01.01.10360
PFYN	10.0	G1/8-AG	10.01.01.00297	10.01.01.11134	10.01.01.00279	10.01.01.10383	10.01.01.00291	10.01.01.00285	10.01.01.10397
PFYN	10.0	G1/8-IG	10.01.01.00273	10.01.01.11148	10.01.01.00255	10.01.01.10349	10.01.01.00267	10.01.01.00261	10.01.01.10361
PFYN	15.0	G1/8-AG	10.01.01.00183	10.01.01.11135	10.01.01.00141	10.01.01.10384	10.01.01.00169	10.01.01.00155	10.01.01.10398
PFYN	15.0	G1/8-IG	10.01.01.00127	10.01.01.11149	10.01.01.00085	10.01.01.10350	10.01.01.00113	10.01.01.00099	10.01.01.10362
PFYN	20.0	G1/8-AG	10.01.01.00184	10.01.01.11136	10.01.01.00142	10.01.01.10385	10.01.01.00170	10.01.01.00156	-
PFYN	20.0	G1/8-IG	10.01.01.00128	10.01.01.11150	10.01.01.00086	10.01.01.10351	10.01.01.00114	10.01.01.00100	-
PFYN	25.0	G1/8-AG	10.01.01.00185	10.01.01.11137	10.01.01.00143	10.01.01.10386	10.01.01.00171	10.01.01.00157	-
PFYN	25.0	G1/8-IG	10.01.01.00129	10.01.01.11151	10.01.01.00087	10.01.01.10352	10.01.01.00115	10.01.01.00101	-
PFYN	30.0	G1/8-AG	10.01.01.00186	10.01.01.11138	10.01.01.00144	10.01.01.10387	10.01.01.00172	10.01.01.00158	-
PFYN	30.0	G1/8-IG	10.01.01.00130	10.01.01.11152	10.01.01.00088	10.01.01.10353	10.01.01.00116	10.01.01.00102	-
PFYN	35.0	G1/8-AG	10.01.01.00187	10.01.01.11139	10.01.01.00145	10.01.01.10388	10.01.01.00173	10.01.01.00159	-
PFYN	35.0	G1/8-IG	10.01.01.00131	10.01.01.11153	10.01.01.00089	10.01.01.10354	10.01.01.00117	10.01.01.00103	-
PFYN	40.0	G1/8-AG	10.01.01.00188	10.01.01.11140	10.01.01.00146	10.01.01.10389	10.01.01.00174	10.01.01.00160	-
PFYN	40.0	G1/8-IG	10.01.01.00132	10.01.01.11154	10.01.01.00090	10.01.01.10355	10.01.01.00118	10.01.01.00104	-
PFYN	50.0	G1/8-AG	10.01.01.00189	10.01.01.11141	10.01.01.00147	10.01.01.10390	10.01.01.00175	10.01.01.00161	-
PFYN	50.0	G1/8-IG	10.01.01.00133	10.01.01.11155	10.01.01.00091	10.01.01.10356	10.01.01.00119	10.01.01.00105	-
PFYN	60.0	G1/4-AG	10.01.01.00190	10.01.01.11142	10.01.01.00148	-	10.01.01.00176	10.01.01.00162	-
PFYN	60.0	G1/4-IG	10.01.01.00134	10.01.01.11156	10.01.01.00092	-	10.01.01.00120	10.01.01.00106	-
PFYN	80.0	G1/4-AG	10.01.01.00191	10.01.01.11143	10.01.01.00149	-	10.01.01.00177	10.01.01.00163	-
PFYN	80.0	G1/4-IG	10.01.01.00135	10.01.01.11157	10.01.01.00093	-	10.01.01.00121	10.01.01.00107	-
PFYN	95.0	G1/4-AG	10.01.01.00192	10.01.01.13774	10.01.01.00150	-	10.01.01.00178	10.01.01.00164	-
PFYN	95.0	G1/4-IG	10.01.01.00136	10.01.01.13762	10.01.01.00094	-	10.01.01.00122	10.01.01.00108	-
PFYN	120.0	G1/2-IG	10.01.01.12052	-	10.01.01.00337	-	-	10.01.01.00338	-
PFYN	150.0	G1/2-IG	-	-	10.01.01.00339	-	-	10.01.01.00340	-
PFYN	200.0	G1/2-IG	-	-	10.01.01.00341	-	-	10.01.01.00342	-

*Additional material specifications at beginning of the section "Vacuum Suction Cups"

Flat Suction Cups PFYN

Suction area (Ø) from 1 mm to 200 mm

Ordering data Spare parts Flat Suction Cups PFYN

Type	Suction cup material with SHA: *							
	FPM-65	HT1-60	HT2-65	NBR-55	NBR-CO-55	PU-55	SI-55	SI-CO-55
PFG 1.0	-	-	-	10.01.01.00001	10.01.01.10335	-	10.01.01.00021	-
PFG 1.5	-	-	-	10.01.01.00002	10.01.01.10336	-	10.01.01.00022	-
PFG 2.0	-	10.01.01.12967	-	10.01.01.00003	10.01.01.10063	-	10.01.01.00023	10.01.01.10050
PFG 3.5	-	10.01.01.12981	10.01.01.00064	10.01.01.00004	10.01.01.10042	-	10.01.01.00024	10.01.01.00752
PFG 5.0	10.01.01.00067	10.01.01.11158	-	10.01.01.00007	10.01.01.10064	-	10.01.01.00027	10.01.01.10051
PFG 6.0	10.01.01.00068	10.01.01.11159	-	10.01.01.00008	10.01.01.10065	-	10.01.01.00028	10.01.01.00626
PFG 8.0	10.01.01.00069	10.01.01.11160	-	10.01.01.00009	10.01.01.10043	10.01.01.00049	10.01.01.00029	10.01.01.00647
PFG 10.0	10.01.01.00070	10.01.01.11161	-	10.01.01.00010	10.01.01.10066	10.01.01.00050	10.01.01.00030	10.01.01.00701
PFG 15.0	10.01.01.00071	10.01.01.11162	-	10.01.01.00011	10.01.01.10067	10.01.01.00051	10.01.01.00031	10.01.01.00627
PFG 20.0	10.01.01.00072	10.01.01.11163	-	10.01.01.00012	10.01.01.10337	10.01.01.00052	10.01.01.00032	-
PFG 25.0	10.01.01.00073	10.01.01.11164	-	10.01.01.00013	10.01.01.10338	10.01.01.00053	10.01.01.00033	-
PFG 30.0	10.01.01.00074	10.01.01.11165	-	10.01.01.00014	10.01.01.10339	10.01.01.00054	10.01.01.00034	-
PFG 35.0	10.01.01.00075	10.01.01.11166	-	10.01.01.00015	10.01.01.10340	10.01.01.00055	10.01.01.00035	-
PFG 40.0	10.01.01.00076	10.01.01.11167	-	10.01.01.00016	10.01.01.10341	10.01.01.00056	10.01.01.00036	-
PFG 50.0	10.01.01.00077	10.01.01.11168	-	10.01.01.00017	10.01.01.10342	10.01.01.00057	10.01.01.00037	-
PFG 60.0	10.01.01.00078	10.01.01.11169	-	10.01.01.00018	-	10.01.01.00058	10.01.01.00038	-
PFG 80.0	10.01.01.00079	10.01.01.11170	-	10.01.01.00019	-	10.01.01.00059	10.01.01.00039	-
PFG 95.0	10.01.01.00080	10.01.01.13160	-	10.01.01.00020	-	10.01.01.00060	10.01.01.00040	-
PFG 120.0	10.01.01.00389	-	-	10.01.01.00331	-	-	10.01.01.00332	-
PFG 150.0	-	10.01.01.13445	-	10.01.01.00333	-	-	10.01.01.00334	-
PFG 200.0	-	-	-	10.01.01.00335	-	-	10.01.01.00336	-

*Additional material specifications at beginning of the section "Vacuum Suction Cups"

Type	Spare parts			Part no.
PFYN 1.0	M3-AG	Suction cup connection nipple	SA-NIP N001 M3-AG DN40	10.01.01.00315
PFYN 1.5	M3-AG	Suction cup connection nipple	SA-NIP N002 M3-AG DN70	10.01.01.00314
PFYN 2.0	M3-AG	Suction cup connection nipple	SA-NIP N003 M3-AG DN100	10.01.01.00316
PFYN 3.5	M3-AG	Suction cup connection nipple	SA-NIP N003 M3-AG DN100	10.01.01.00316
PFYN 5.0	M5-AG	Suction cup connection nipple	SA-NIP N004 M5-AG DN200	10.01.01.03526
PFYN 6.0	M5-AG	Suction cup connection nipple	SA-NIP N004 M5-AG DN200	10.01.01.03526
PFYN 8.0	M5-AG	Suction cup connection nipple	SA-NIP N004 M5-AG DN200	10.01.01.03526
PFYN 10.0	M5-AG	Suction cup connection nipple	SA-NIP N004 M5-AG DN200	10.01.01.03526
PFYN 10.0	G1/8-AG	Suction cup connection nipple	SA-NIP N004 G1/8-AG DN200	10.01.01.03528
PFYN 15.0	G1/8-AG	Suction cup connection nipple	SA-NIP N005 G1/8-AG DN200	10.01.01.03529
PFYN 20.0	G1/8-AG	Suction cup connection nipple	SA-NIP N006 G1/8-AG DN200	10.01.01.03530
PFYN 25.0	G1/8-AG	Suction cup connection nipple	SA-NIP N007 G1/8-AG DN240	10.01.01.03531
PFYN 30.0	G1/8-AG	Suction cup connection nipple	SA-NIP N007 G1/8-AG DN240	10.01.01.03531
PFYN 35.0	G1/8-AG	Suction cup connection nipple	SA-NIP N007 G1/8-AG DN240	10.01.01.03531
PFYN 40.0	G1/8-AG	Suction cup connection nipple	SA-NIP N007 G1/8-AG DN240	10.01.01.03531
PFYN 50.0	G1/8-AG	Suction cup connection nipple	SA-NIP N008 G1/8-AG DN350	10.01.01.03532
PFYN 60.0	G1/4-AG	Suction cup connection nipple (inst)	SA-NIP N009 G1/4-AG	10.01.01.10097
PFYN 80.0	G1/4-AG	Suction cup connection nipple (inst)	SA-NIP N009 G1/4-AG	10.01.01.10097
PFYN 95.0	G1/4-AG	Suction cup connection nipple (inst)	SA-NIP N009 G1/4-AG	10.01.01.10097

Type	Spare parts			Part no.
PFYN 5	M5-IG	Suction cup connection nipple	SA-NIP N004 M5-IG DN200	10.01.01.03518
PFYN 6	M5-IG	Suction cup connection nipple	SA-NIP N004 M5-IG DN200	10.01.01.03518
PFYN 8	M5-IG	Suction cup connection nipple	SA-NIP N004 M5-IG DN200	10.01.01.03518
PFYN 10	M5-IG	Suction cup connection nipple	SA-NIP N004 M5-IG DN200	10.01.01.03518
PFYN 10	G1/8-IG	Suction cup connection nipple	SA-NIP N004 G1/8-IG DN200	10.01.01.03520
PFYN 15	G1/8-IG	Suction cup connection nipple	SA-NIP N005 G1/8-IG DN200	10.01.01.03521

Flat Suction Cups PFYN

Suction area (Ø) from 1 mm to 200 mm

Type		Spare parts			Part no.
PFYN	20	G1/8-IG	Suction cup connection nipple	SA-NIP N006 G1/8-IG DN200	10.01.01.03522
PFYN	25	G1/8-IG	Suction cup connection nipple	SA-NIP N007 G1/8-IG DN350	10.01.01.03523
PFYN	30	G1/8-IG	Suction cup connection nipple	SA-NIP N007 G1/8-IG DN350	10.01.01.03523
PFYN	35	G1/8-IG	Suction cup connection nipple	SA-NIP N007 G1/8-IG DN350	10.01.01.03523
PFYN	40	G1/8-IG	Suction cup connection nipple	SA-NIP N007 G1/8-IG DN350	10.01.01.03523
PFYN	50	G1/8-IG	Suction cup connection nipple	SA-NIP N008 G1/8-IG DN350	10.01.01.03524
PFYN	60	G1/4-IG	Suction cup connection nipple (inst)	SA-NIP N009 G1/4-IG	10.01.01.10096
PFYN	80	G1/4-IG	Suction cup connection nipple (inst)	SA-NIP N009 G1/4-IG	10.01.01.10096
PFYN	95	G1/4-IG	Suction cup connection nipple (inst)	SA-NIP N009 G1/4-IG	10.01.01.10096
PFYN	120	G1/2-IG	Suction cup connection nipple (inst)	SA-NIP N010 G1/2-IG	10.01.01.00796
PFYN	150	G1/2-IG	Suction cup connection nipple (inst)	SA-NIP N010 G1/2-IG	10.01.01.00796
PFYN	200	G1/2-IG	Suction cup connection nipple (inst)	SA-NIP N010 G1/2-IG	10.01.01.00796

Ordering data Accessories Flat Suction Cups PFYN

Designation 2

Technical data Flat Suction Cups PFYN

Type		Suction force (-600 mbar) [N]*	Volume [cm ³]	Workpiece radius min. (convex) [mm]	Hose diameter (recom.) d [mm]**	Nipple family
PFYN	1.0	0.03	0.001	2	2	N 001
PFYN	1.5	0.06	0.001	2	2	N 002
PFYN	2.0	0.12	0.001	2	2	N 003
PFYN	3.5	0.42	0.002	8	2	N 003
PFYN	5.0	0.75	0.005	8	2	N 004
PFYN	6.0	1.20	0.008	8	2	N 004
PFYN	8.0	2.30	0.030	10	2	N 004
PFYN	10.0	4.00	0.070	13	2	N 004
PFYN	15.0	9.00	0.400	13	4	N 005
PFYN	20.0	15.50	0.800	20	4	N 006
PFYN	25.0	26.50	1.300	25	4	N 007
PFYN	30.0	34.00	1.300	40	4	N 007
PFYN	35.0	44.00	2.700	50	4	N 007
PFYN	40.0	57.70	3.800	50	4	N 007
PFYN	50.0	91.00	7.000	75	4	N 008
PFYN	60.0	125.00	10.000	100	6	N 009
PFYN	80.0	260.00	25.000	150	6	N 009
PFYN	95.0	350.00	35.000	200	6	N 009
PFYN	120.0	540.00	77.800	300	9	N 010
PFYN	150.0	842.00	176.300	300	9	N 010
PFYN	200.0	1,498.00	427.000	400	9	N 010

*The specified suction forces are theoretical values at a vacuum of -0.6 bar and with a smooth, dry workpiece surface - they do not include a safety factor

**The recommended hose diameter is based on a hose length of approx. 2 m

Flat Suction Cups PFYN

Suction area (\emptyset) from 1 mm to 200 mm

Design data Flat Suction Cups PFYN

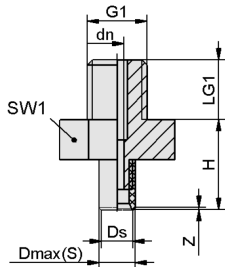

PFYN 1 - 1.5 AG

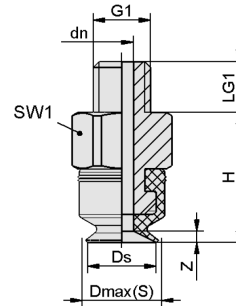

PFYN 2 - 10 AG

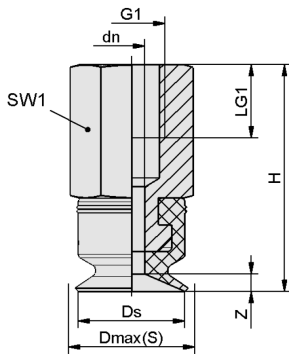

PFYN 5 - 10 IG

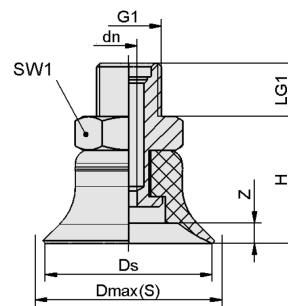

PFYN 15 - 50 AG

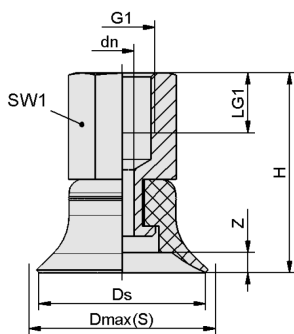

PFYN 15 - 50 IG

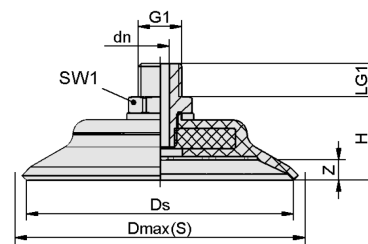

PFYN 60 - 95 AG

Flat Suction Cups PFYN

Suction area (\emptyset) from 1 mm to 200 mm

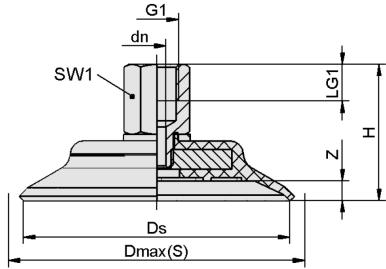

PFYN 60 - 95 IG

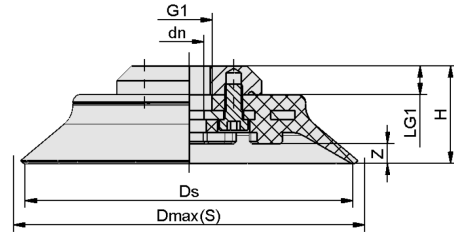

PFYN 120 - 200 IG

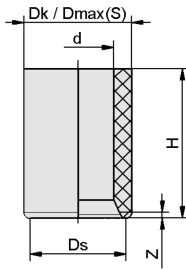

PFG 1 - 1.5

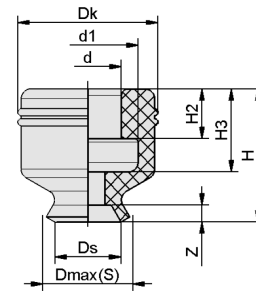

PFG 2 - 10

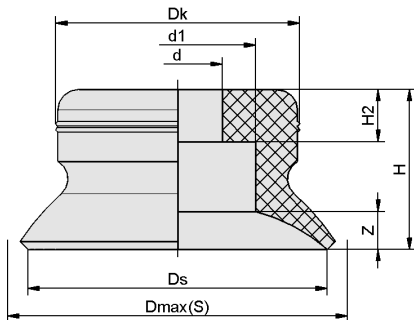

PFG 15 - 50

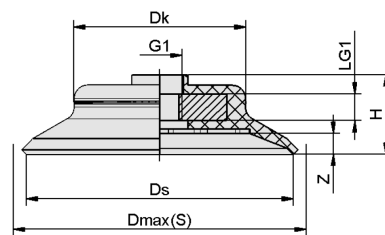

PFG 60 - 95

Flat Suction Cups (Round)



Flat Suction Cups PFYN

Suction area (\emptyset) from 1 mm to 200 mm

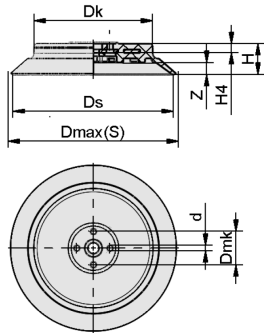

PFG 120 - 200

Flat Suction Cups PFYN

Suction area (Ø) from 1 mm to 200 mm

Design data Flat Suction Cups PFYN

Type	dn [mm]	Dmax(S) [mm]*	Ds [mm]	G1	H [mm]	LG1 [mm]	SW1 [mm]	Z (Stroke) [mm]		
PFYN	1.0	M3-AG	0.4	1.2	1.00	M3-M	3.6	3.0	5	0.1
PFYN	1.5	M3-AG	0.7	1.8	1.50	M3-M	4.5	3.0	5	0.1
PFYN	2.0	M3-AG	1.0	2.5	2.00	M3-M	6.0	3.0	5	0.5
PFYN	3.5	M3-AG	1.0	4.0	3.50	M3-M	6.0	3.0	5	0.5
PFYN	5.0	M5-AG	1.5	5.5	5.00	M5-M	11.5	4.5	8	0.9
PFYN	5.0	M5-IG	1.5	5.5	5.00	M5-F	16.5	5.5	8	0.9
PFYN	6.0	M5-AG	2.0	6.5	6.00	M5-M	11.5	4.5	8	1.0
PFYN	6.0	M5-IG	2.0	6.5	6.00	M5-F	16.5	5.5	8	1.0
PFYN	8.0	M5-AG	2.0	9.0	8.00	M5-M	12.0	4.5	8	1.3
PFYN	8.0	M5-IG	2.0	9.0	8.00	M5-F	17.0	5.5	8	1.3
PFYN	10.0	M5-AG	2.0	11.5	10.00	M5-M	12.5	4.5	8	1.4
PFYN	10.0	M5-IG	2.0	11.5	10.00	M5-F	17.5	5.5	8	1.4
PFYN	10.0	G1/8-AG	2.0	11.5	10.00	G1/8"-M	12.5	8.0	14	1.4
PFYN	10.0	G1/8-IG	2.0	11.5	10.00	G1/8"-F	23.5	9.0	14	1.4
PFYN	15.0	G1/8-AG	2.0	17.5	15.00	G1/8"-M	13.0	8.0	14	1.9
PFYN	15.0	G1/8-IG	2.0	17.5	15.00	G1/8"-F	24.0	9.0	14	1.9
PFYN	20.0	G1/8-AG	2.0	23.0	20.00	G1/8"-M	15.0	8.0	14	2.2
PFYN	20.0	G1/8-IG	2.0	23.0	20.00	G1/8"-F	26.0	9.0	14	2.2
PFYN	25.0	G1/8-AG	2.4	27.5	25.00	G1/8"-M	19.0	8.0	14	3.0
PFYN	25.0	G1/8-IG	3.5	27.5	25.00	G1/8"-F	30.0	9.0	14	3.0
PFYN	30.0	G1/8-AG	2.4	31.5	28.80	G1/8"-M	17.0	8.0	14	2.0
PFYN	30.0	G1/8-IG	3.5	31.5	28.80	G1/8"-F	28.0	9.0	14	2.0
PFYN	35.0	G1/8-AG	2.4	38.0	35.00	G1/8"-M	19.0	8.0	14	3.0
PFYN	35.0	G1/8-IG	3.5	38.0	35.00	G1/8"-F	30.0	9.0	14	3.0
PFYN	40.0	G1/8-AG	2.4	43.0	40.00	G1/8"-M	19.0	8.0	14	3.5
PFYN	40.0	G1/8-IG	3.5	43.0	40.00	G1/8"-F	30.0	9.0	14	3.5
PFYN	50.0	G1/8-AG	2.4	53.5	50.00	G1/8"-M	20.0	8.0	14	4.0
PFYN	50.0	G1/8-IG	3.5	53.5	50.00	G1/8"-F	31.0	9.0	14	4.0
PFYN	60.0	G1/4-AG	5.5	64.0	60.00	G1/4"-M	23.0	10.0	17	4.7
PFYN	60.0	G1/4-IG	5.5	64.0	60.00	G1/4"-F	39.0	11.0	17	4.7
PFYN	80.0	G1/4-AG	5.5	86.0	80.00	G1/4"-M	25.0	10.0	17	6.0
PFYN	80.0	G1/4-IG	5.5	86.0	80.00	G1/4"-F	41.5	11.0	17	6.0
PFYN	95.0	G1/4-AG	5.5	102.0	95.00	G1/4"-M	25.5	10.0	17	6.0
PFYN	95.0	G1/4-IG	5.5	102.0	95.00	G1/4"-F	41.5	11.0	17	6.0
PFYN	120.0	G1/2-IG	13.5	124.0	120.00	G1/2"-F	37.5	13.0	-	6.0
PFYN	150.0	G1/2-IG	13.5	158.0	147.50	G1/2"-F	45.5	13.0	-	9.0
PFYN	200.0	G1/2-IG	13.5	222.0	193.00	G1/2"-F	50.5	13.0	-	13.0

*External dimension of the suction cup when it is pressed against the workpiece by the vacuum

Type*	d [mm]	d1 [mm]	Dk [mm]	Dmax(S) [mm]**	Dmk [mm]	Ds [mm]	G1	H [mm]	H2 [mm]	H3 [mm]	H4 [mm]	LG1 [mm]	Z (Stroke) [mm]
PFG	1.0	0.8	-	1.2	1.2	-	1.0	-	1.6	-	-	-	0.1
PFG	1.5	1.2	-	1.8	1.8	-	1.5	-	2.5	-	-	-	0.1
PFG	2.0	2.0	3.0	4.2	3.0	-	2.0	-	4.0	1.5	2.5	-	0.5
PFG	3.5	2.0	3.0	4.2	4.0	-	3.5	-	4.0	1.5	2.5	-	0.5
PFG	5.0	4.0	6.0	7.7	5.5	-	5.0	-	6.5	2.0	4.0	-	0.9
PFG	6.0	4.0	6.0	7.7	6.5	-	6.0	-	6.5	2.0	4.0	-	1.0
PFG	8.0	4.0	6.0	8.2	9.0	-	8.0	-	7.0	2.0	4.0	-	1.3
PFG	10.0	4.0	6.0	8.7	11.5	-	10.0	-	7.5	2.0	4.0	-	1.4
PFG	15.0	4.5	7.8	12.2	17.5	-	15.0	-	8.0	2.6	-	-	1.9
PFG	20.0	4.5	11.0	15.2	23.0	-	20.0	-	10.0	4.5	-	-	2.2
PFG	25.0	6.0	11.0	16.2	27.5	-	25.0	-	14.0	7.0	-	-	3.0

Flat Suction Cups PFYN

Suction area (Ø) from 1 mm to 200 mm

Type*	d [mm]	d1 [mm]	Dk [mm]	Dmax(S) [mm]**	Dmk [mm]	Ds [mm]	G1	H [mm]	H2 [mm]	H3 [mm]	H4 [mm]	LG1 [mm]	Z (Stroke) [mm]
PFG	30.0	6.0	11.0	15.1	31.5	-	28.8	-	12.0	7.0	-	-	2.0
PFG	35.0	6.0	11.0	20.5	38.0	-	35.0	-	14.0	7.0	-	-	3.0
PFG	40.0	6.0	11.0	24.3	43.0	-	40.0	-	14.0	7.0	-	-	3.5
PFG	50.0	8.0	20.0	29.1	53.5	-	50.0	-	15.0	7.0	-	-	4.0
PFG	60.0	-	-	38.7	64.0	-	60.0	M10x1.25-F	18.0	-	-	-	6
PFG	80.0	-	-	52.3	86.0	-	80.0	M10x1.25-F	20.5	-	-	-	6
PFG	95.0	-	-	68.2	102.0	-	95.0	M10x1.25-F	21.5	-	-	-	6
PFG	120.0	7.0	-	89.5	124.0	40	120.0	-	23.5	-	-	8.5	6.0
PFG	150.0	7.0	-	104.5	158.0	40	147.5	-	31.0	-	-	11.0	9.0
PFG	200.0	7.0	-	142.5	222.0	40	193.0	-	37.0	-	-	11.0	13.0

*Acceptable dimensional tolerances for rubber parts concerning to DIN ISO 3302-1 E3

**External dimension of the suction cup when it is pressed against the workpiece by the vacuum