

# FIL + REG + LUB bit



Complete mini-FRL unit with rolling diaphragm.

- High flow rates with reduced pressure drop
- Excellent degree of condensate separation
- Quantity of lubricant proportioned to air flow
- Activates at low flow rates



TECHNICAL DATA	F + R + L BIT 1/8"		F + R + L BIT 1/4"	
	1/8"		1/4"	
Threaded port	1/8"		1/4"	
Setting range	0 to 2 - 0 to 4 - 0 to 8 - 0 to 12			
Degree of filtration	µm	5 (yellow)	20 (white)	50 (blue)
Type of lubrication		Oil mist		
Max. inlet pressure	MPa	1.3		
	bar	13		
	psi	188		
Flow rate at 6.3 bar (0.63 MPa to 91 psi) ΔP 0.5 bar (0.05 MPa to 7 psi)	Nl/min	150		
	scfm	5.3		
Flow rate at 6.3 bar (0.63 MPa to 91 psi) ΔP 1 bar (0.1 MPa to 14 psi)	Nl/min	280		
	scfm	10		
Max temperature at 1 MPa; 10 bar; 145 psi	°C	50		
	°F	122		
Weight	g	160		
Wall fixing screws		M4 by means of the bracket provided		
Gauge port		G1/8"		
Mounting position		Vertical		
Condensate drain		RMSA: drain with manual condensate discharge and automatic discharge at zero pressure SAC: automatic drain with condensate discharge.		
Fluid		<b>Operates by pressure drop – requires variable air take-offs.</b> Compressed air		
Notes		See chapters regarding individual elements.		

UNITS

FIL + REG + LUB bit

## DIMENSIONS

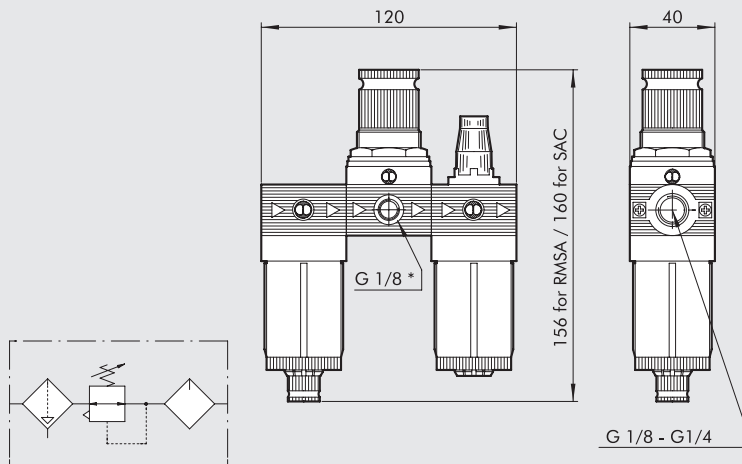

\* Pressure gauge port

**SYNOPTIC, SIZES AND VERSIONS**

FRL ELEMENT	BIT SIZE	1/8 THREADED PORT	5 DEGREE OF FILTRATION	02 SETTING RANGE	RMSA CONDENSATE DRAIN
FRL	BIT	1/8 1/4	5 = 5 µm 20 = 20 µm 50 = 50 µm	02 = 0 to 2 bar 04 = 0 to 4 bar 08 = 0 to 8 bar 012 = 0 to 12 bar	RMSA SAC

RMSA: drain with manual condensate discharge and automatic discharge at zero pressure  
 SAC: automatic drain with condensate discharge.  
**Operates by pressure drop – requires variable air take-offs.**

**ORDERING CODES**

Code	Description
5104008	FRL BIT 1/8 20 08 RMSA
5104011	FRL BIT 1/8 20 012 RMSA
5204008	FRL BIT 1/4 20 08 RMSA
5204011	FRL BIT 1/4 20 012 RMSA

The following versions are available on request:

- with 5 µm or 50 µm degree of filtration
- with 0-2 bar or 0-4 bar setting range
- with SAC condensate discharge

**NOTES**

UNITS

FIL + REG + LUB bit

# bit ACCESSORIES

## ACCESSORIES FOR STANDARD bit AND SERIES F bit FOR WATER

### PRESSURE GAUGE

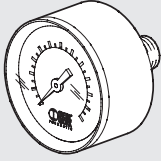

Code	Description
9700102 *	M 40 1/8 04
9700101 *	M 40 1/8 012

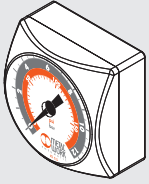

9700109 *	M 40x40 1/8 04
9700110 *	M 40x40 1/8 012

\* Cannot be used with water

### DOME DISASSEMBLY SPANNER

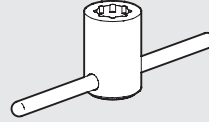

Code	Description
9220701	Cover LUB spanner

### R/FR FIXING BRACKET

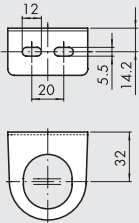

Code	Description
9200701	SF100 - BIT - ND 1/4 - SY1

### COVER DISASSEMBLY SPANNER

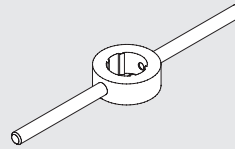

Code	Description
9170401	CS CS BIT

### ASSEMBLY PLATE (PAIR)

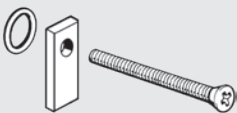

Code	Description
9170201	PAB 1/8 - 1/4 BIT

### REDUCER PLUG DISASSEMBLY SPANNER

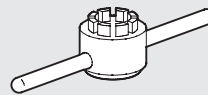

Code	Description
9170501	CS OTR BIT

### WALL MOUNTING BRACKET (PAIR)

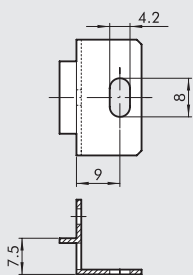

Code	Description
9170301	SFB 1/8 - 1/4 BIT

### BOWL DISASSEMBLY SPANNER

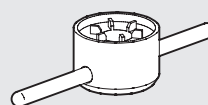

Code	Description
9170601	CS TF - TL BIT - SY1

# bit SPARE PARTS

## SPARE PARTS FOR STANDARD bit

### UPPER COVER FOR MR

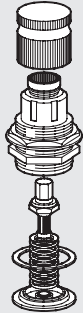

Code	Description
9250805	Spares CS 1/8 1/4 BIT 02
9250806	Spares CS 1/8 1/4 BIT 04
9250807	Spares CS 1/8 1/4 BIT 08
9250808	Spares CS 1/8 1/4 BIT 012

### FILTER AND FILTER-REGULATOR BOWL

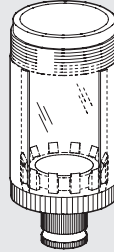

Code	Description
9255001	Spares TF 1/8 1/4 BIT RMSA
9255101	Spares TF 1/8 1/4 BIT SAC

### UPPER COVER FOR MR FC

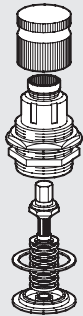

Code	Description
9250817	Spares CS FC 1/8 1/4 BIT 02
9250818	Spares CS FC 1/8 1/4 BIT 04

### AUTOMATIC DRAIN (SAC)



Code	Description
9000803	Spares SAC automatic drain

### UPPER COVER FOR MRA

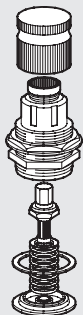

Code	Description
9250809	Spares CSA 1/8 - 1/4 BIT 02
9250814	Spares CSA 1/8 - 1/4 BIT 04
9250815	Spares CSA 1/8 - 1/4 BIT 08
9250816	Spares CSA 1/8 - 1/4 BIT 012

### LUBRICATOR BOWL

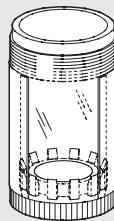

Code	Description
9251402	Spares TL 1/8 1/4 BIT

### COMPLETE POPPET FOR MR AND MRA

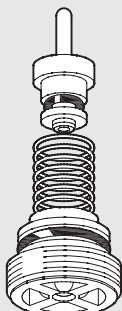

Code	Description
9250705	Spares poppet for MR
9250706	Spares poppet for MR-SR (rapid drain)
9250708	Spares poppet for MRA

### FILTER ELEMENT

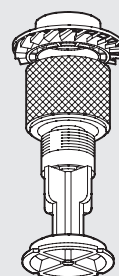

Code	Description
9251708	Spares FP 1/8-1/4 BIT 5 (yellow)
9251709	Spares FP 1/8-1/4 BIT 20 (white)
9251710	Spares FP 1/8-1/4 BIT 50 (blue)

**FILTER CARTRIDGE**

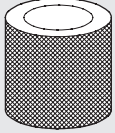

Code	Description
9251808	Spares filter cartridge BIT 5 (yellow)
9251809	Spares filter cartridge BIT 20 (white)
9251810	Spares filter cartridge BIT 50 (blue)

**DEPURATOR FILTER ELEMENT**

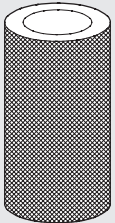

Code	Description
9251712	Spares FP DEP. 1/8 1/4 BIT

**COMPLETE POPPET FOR FR**



Code	Description
9250905	Spares OTFR 1/8 1/4 BIT 5 (yellow)
9250906	Spares OTFR 1/8 1/4 BIT 20 (white)
9250907	Spares OTFR 1/8 1/4 BIT 50 (blue)

**TRANSPARENT LUBRICATOR COVER**

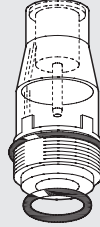

Code	Description
9251302	Spares CVL 100-200-300-400 BIT

**SPRING FOR MR, FR**

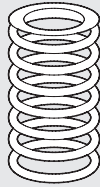

Code	Description
9250610	Spares MO 02 BIT
9250611	Spares MO 04 BIT
9250612	Spares MO 08 BIT
9250613	Spares MO 012 BIT

**NOTES**

**SPARE PARTS FOR SERIES F bit FOR WATER**

**FILTER ELEMENT**



Code	Description
9251709	Spares FP 1/8-1/4 BIT 20 (white)

**SPRING FOR REG F, FR F**



Code	Description
9250610	Spares MO 02 BIT
9250611	Spares MO 04 BIT
9250612	Spares MO 08 BIT
9250613	Spares MO 012 BIT

**FILTER CARTRIDGE**

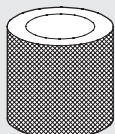

Code	Description
9251809	Spares filter cartridge BIT 20 (white)

**NOTES**