

New deal SUB-BASE

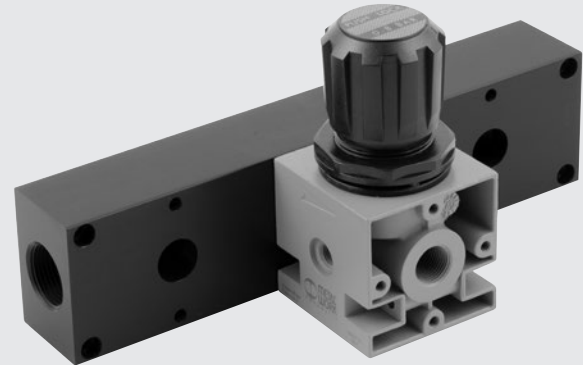

With the New deal sub-base, more than one regulators can be mounted in parallel using a single pressure supply source.



DIMENSIONS

3 POSITION

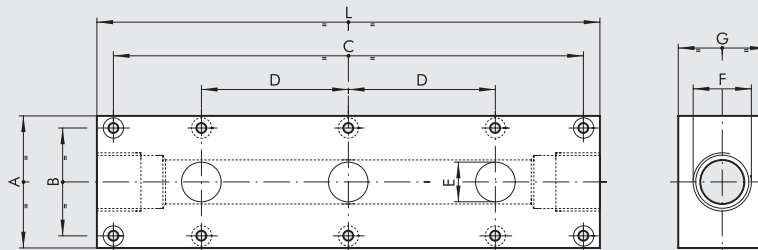

2 POSITION

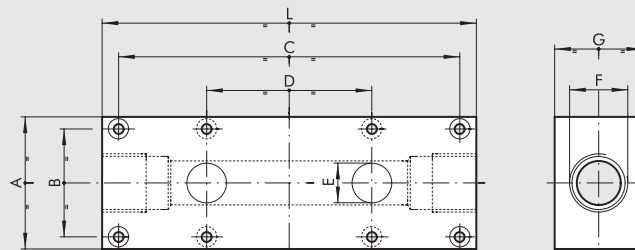

	ND 1/4"		ND 3/8" - 1/2"		ND 3/4" - 1"	
	2 positions	3 positions	2 positions	3 positions	2 positions	3 positions
A	50	50	60	60	80	80
B	34	34	49	49	64	64
C	113	165	155	230	190	280
D	52	52	75	75	90	90
E	1/4"	1/4"	18	18	31	31
F	1/2"	1/2"	3/4"	3/4"	1 1/4"	1 1/4"
G	30	30	40	40	50	50
L	128	180	170	245	210	300
Weight [kg]	0.45	0.62	0.94	1.4	1.5	1.7

ORDERING CODES

Code	Description
9200201	SB 1/4 sub-base 2 pos.
9400201	SB 1/2 sub-base 2 pos.
9600201	SB 3/4 sub-base 2 pos.
9200301	SB 1/4 sub-base 3 pos.
9400301	SB 1/2 sub-base 3 pos.
9600301	SB 3/4 sub-base 3 pos.

Newdeal ACCESSORIES



MOUNTING BRACKET FOR REG.

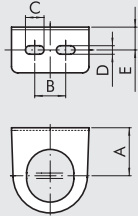

Code	Description
9200701	SF 1/4
9400701	SF 1/2

Code	A	B	C	D	E
9200701	32	20	12	5.5	14.2
9400701	42	40	12	5.5	15

PRESSURE GAUGE

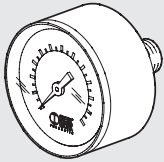

Code	Description
9700102	M 40 1/8 04
9700101	M 40 1/8 012
9800102	M 50 1/8 04
9800101	M 50 1/8 012
9900101	M 63 1/4 012

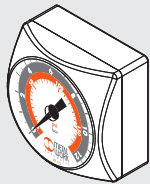

9700109	M 40x40 1/8 04
9700110	M 40x40 1/8 012

TIE RODS

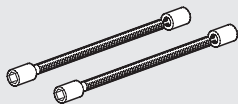

Code	Description
9200901	T 1/4 F+L tie rods
9400901	T 1/2 F+L tie rods
9600901	T 3/4 F+L tie rods

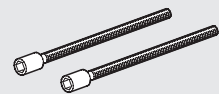

9604402	V3V+F+R 3/4-1 tie rods
---------	------------------------

ADAPTER FOR V3V

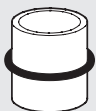

Code	Description
9201001	Adapt. X V3V+FR/D 1/4
9401001	Adapt. X V3V+D 3/8
9401002	Adapt. X V3V+D 1/2
9601001	Adapt. X V3V+F 1

REGULATOR CONNECTION BLOCK

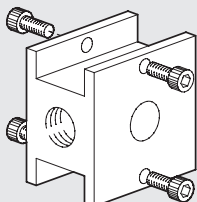

Code	Description	Weight [g]
9200501	BC 1/4 block	90
9400501	BC 1/2 block	244
9600501	BC 3/4 block	428

SPACERS FOR FRL WALL MOUNTING

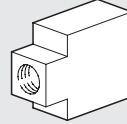

Code	Description
9200601	DF 1/4 spacer
9400601	DF 1/2 spacer
9600601	DF 3/4 spacer

DISASSEMBLY TOOL FOR BOWL

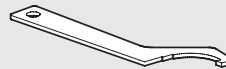

Code	Description
9601501	Disassembly key

ASSEMBLY SCREWS (2 PIECES)



Code	Description
9250001	CVA 1/4 screw M4x40
9250002	CVA 1/4 screw M4x82 V3V+F+R
9450001	CVA 1/2 screw M5x55
9450002	CVA 3/8 1/2 screw M5x60 V3V+R
9450003	CVA 3/8 1/2 screw M5x120 V3V+F+R
9650001	CVA 3/4 screw M6X70

REVERSE PLATE CNOMO CONTROL FOR V3V 3/4"-1"

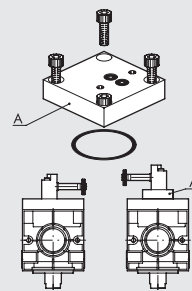

Code	Description	Weight [g]
9640201	Reverse plate kit V3V cnomo control	86

PLATE FOR REMOTE CONTROL FOR V3V 3/4"-1"

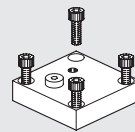

Code	Description	Weight [g]
9640001	Remote control plate kit	84

REG OR V3V END PLATE

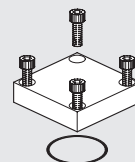

Code	Description	Weight [g]
9640101	End plate kit for regulator or V3V	82

KEY CONTROL FOR V3V 3/4"-1"

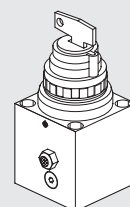

Code	Description	Weight [g]
9640301	Key control kit for V3V	364

MANUAL CONTROL FOR V3V 3/4"-1"

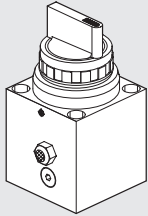

Code	Description	Weight [g]
9640401	Manual control kit for V3V	340

CNOMO CONTROL FOR V3V 3/4"-1"

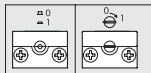
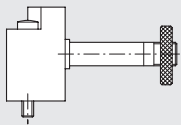

Code	Description
9453920	Elpon cnomo control kit, manual monostable
9453922	Elpon cnomo control kit, manual bistable

PILOT REGULATOR FOR ND 3/4"-1"

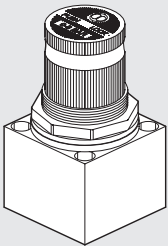

Code	Description	Weight [g]
9640501	02 pilot regulator kit	220
9640502	04 pilot regulator kit	220
9640503	08 pilot regulator kit	220
9640504	012 pilot regulator kit	220

COIL 22 mm FOR V3V ELPN

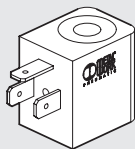

Code	Description
W0215000151	Coil 22 Ø 8 BA 2W-12VDC
W0215000101	Coil 22 Ø 8 BA 2W-24VDC
W0215000111	Coil 22 Ø 8 BA 3.5VA-24VAC
W0215000121	Coil 22 Ø 8 BA 3.5VA-110VAC
W0215000131	Coil 22 Ø 8 BA 3.5VA-220VAC

Electrical connection DIN 43650 B-IND

COIL 22 mm FOR V3V ELPN

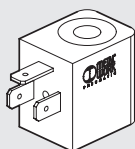

Code	Description
W0215000251	Coil 22 Ø 8 BA 2W-12VDC UR
W0215000201	Coil 22 Ø 8 BA 2W-24VDC UR
W0215000211	Coil 22 Ø 8 BA 3.5VA-24VAC UR
W0215000221	Coil 22 Ø 8 BA 3.5VA-110VAC UR
W0215000231	Coil 22 Ø 8 BA 3.5VA-220VAC UR

Electrical connection DIN 43650 B-IND

COIL 30 mm FOR V3V ELPN

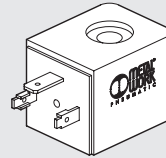

Code	Description
W0210010100	Coil 30 Ø 8 2W 24VDC
W0210011100	Coil 30 Ø 8 3.5VA 24VAC 50/60HZ
W0210012100	Coil 30 Ø 8 3.5VA 110VAC 50/60HZ
W0210013100	Coil 30 Ø 8 3.5VA 220VAC 50/60HZ

Electrical connection DIN 43650 - A

ELECTRIC CONNECTOR 22 mm FOR COILS DIN 43650 B-IND

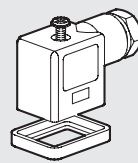

Code	Description
W0970510011	Connector standard
W0970510012	Connector 22 LED 24V
W0970510013	Connector 22 LED 110V
W0970510014	Connector 22 LED 220V
W0970510015	Connector 22 LED VDR 24V
W0970510016	Connector 22 LED VDR 110V
W0970510017	Connector 22 LED VDR 220V
W0970510070	Connector 22 ATEX II 2 GD

ELECTRIC CONNECTOR 30 mm FOR COILS DIN 43650-A

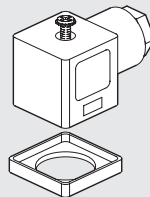

Code	Description
W0970520033	Connector standard
W0970520034	Connector 30 LED 24V
W0970520035	Connector 30 LED 110V
W0970520036	Connector 30 LED 220V
W0970520037	Connector 30 VDR 24V
W0970520038	Connector 30 VDR 110V
W0970520039	Connector 30 VDR 220V

KIT COIL EEXM

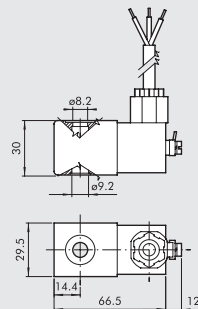

Code	Description
0227606913	Kit for coil 30 24 VDC EEXMT5 cable 3m
0227606915	Kit for coil 30 24 VDC EEXMT5 cable 5m
0227608013	Kit for coil 30 24 VAC EEXMT5 cable 3m
0227608015	Kit for coil 30 24 VAC EEXMT5 cable 5m
0227608023	Kit for coil 30 110 VAC EEXMT5 cable 3m
0227608025	Kit for coil 30 110 VAC EEXMT5 cable 5m
0227608033	Kit for coil 30 230 VAC EEXMT5 cable 3m
0227608035	Kit for coil 30 230 VAC EEXMT5 cable 5m

According to Atex 2014/34/EU rule,

Ex II 2G Ex mb IIC T4/T5 Gb

Ex II 2D Ex tb IIC T130/T95 °C IP66 Db

N.B.: Supplied complete with adapter for Ø8 mm sleeve

KIT FOR COIL SIDE 22 IP65



Code	Description
0222100100	Kit for coil 22 - IP65

Improved IP65 protection, even after prolonged exposure to atmospheric agents.

Applicable to valves with a technopolymer control.

Newdeal SPARE PARTS



FILTER AND FILTER REGULATOR FILTERING ELEMENT

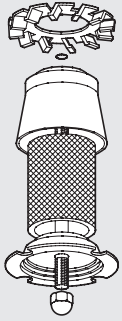

Code	Description
9450102	Spares FP 1/2 20
9450103	Spares FP 1/2 4
9450101	Spares FP 1/2 50
9250102	Spares FP 1/4 20
9250103	Spares FP 1/4 4
9250101	Spares FP 1/4 50
9650103	Spares FP 3/4 4
9650102	Spares FP 3/4 20
9650101	Spares FP 3/4 50

AUTOMATIC DRAIN (RA)

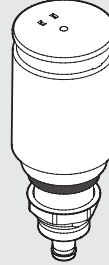

Code	Description
9000802	Spares RA automatic drain

FILTERING ELEMENT FOR DEPURATOR

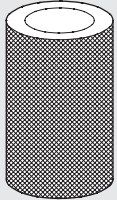

Code	Description
9450105	Spares kit FP DEP. 3/8 1/2

AUTOMATIC DRAIN (SAC)



Code	Description
9000803	Spares SAC automatic drain

METAL FILTER BOWL

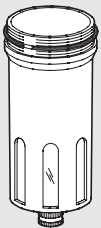

Code	Description
9450301	Spares TMVF 1/2 RMSA
945201	Spares TMVF 1/2 SAC
9250301	Spares TMVF 1/4 RMSA
925201	Spares TMVF 1/4 SAC
9650301	Spares TMVF 3/4 1 RMSA

SPRINGS FOR REGULATORS AND FILTER REGULATOR

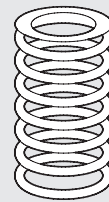

Code	Description
9250601	Spares MO 02 1/4
9250602	Spares MO 04 1/4
9250603	Spares MO 08 1/4
9250604	Spares MO 12 1/4
9450601	Spares MO 04 1/2
9450602	Spares MO 08 1/2
9450603	Spares MO 12 1/2
9650601	Spares MO 04 3/4
9650602	Spares MO 08 3/4
9650603	Spares MO 12 3/4

VENTURI LUBRICATOR DIAPHRAGM

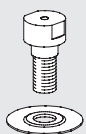

Code	Description
9252001	Spares MB 100 1/4
9352001	Spares MB 200 1/4 3/8 1/2
9652002	Spares MB 3/4-1

METAL LUBRICATOR BOWL

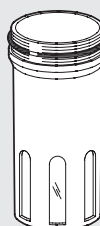

Code	Description
9251201	Spares TMVL 1/4
9451201	Spares TMVL 1/2
9651201	Spares TMVL 3/4

TRANSPARENT LUBRICATOR COVER

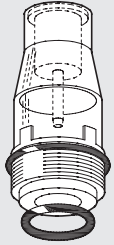

Code	Description
9251302	Spares CVL 100-200-300-400 BIT

DOME DISASSEMBLY SPANNER

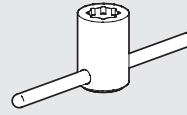

Code	Description
9220701	Acc cover LUB spanner

COMPLETE POPPET FOR FILTER REGULATOR

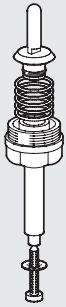

Code	Description
9250901	Spares OTR 1/4
9450901	Spares OTR 1/2

POPPET DISASSEMBLY SPANNER (FOR REG)

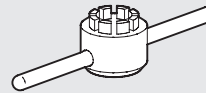

Code	Description
9220501	R cap disass. wr. 100

COMPLETE POPPER FOR REGULATOR

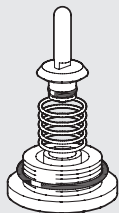

Code	Description
9250701	Spares OTR 1/4
9450701	Spares OTR 1/2
9650701	Spares OTR 3/4

NOTES

UPPER COVER FOR REGULATOR AND FILTER REGULATOR

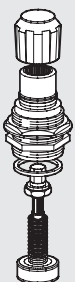

Code	Description
9250801	Spares CS 1/4 02
9250802	Spares CS 1/4 04
9250803	Spares CS 1/4 08
9250804	Spares CS 1/4 012
9450801	Spares CS 1/2 04
9450802	Spares CS 1/2 08
9450803	Spares CS 1/2 12
9650801	Spares CS 3/4 04
9650802	Spares CS 3/4 08
9650803	Spares CS 3/4 12