

LEARNING ABOUT

In the world of pneumatics, which is considered mature, it is rare to encounter completely new and different products. ONE a compressed air treatment unit with a high degree of integration, that encompassed numerous pneumatic functions. In fact, it contains so many innovations that a single patent is not enough to safeguard it against imitation – three separate patent applications have been registered with a total of 39 claims. This unit is so innovative that it won the international novelty award at Fluidtrans Compomac. ONE has a single high-performance valve on the main flow that handles all the functions from regulation to relief. It is controlled by a high-precision pilot regulator with controlled relief, in series with the manual on-off valve, the electric valve and the progressive actuator. Unification of the valve has led to a significant reduction in overall dimensions, enhanced capacity, precision and response speed.



INTEGRATION

One single unit houses the threaded ports, filter, condensate drain, pressure regulator, shut-off valve, soft start valve, pressure switch and three supplementary air intakes.

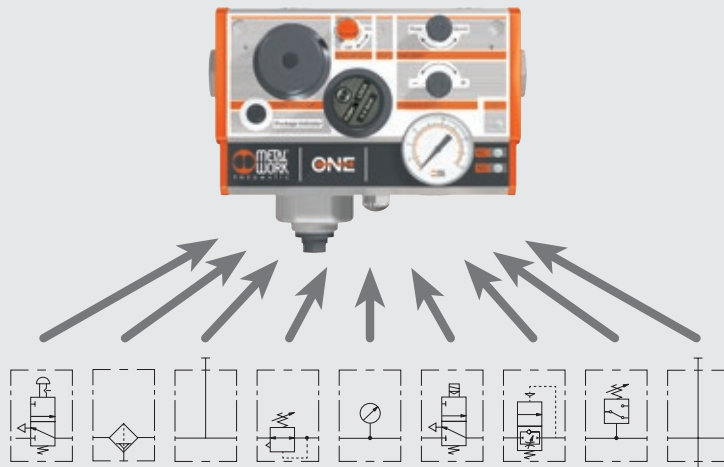

MINIATURISATION



Extremely reduced dimensions, considering the extra-high performance and flow rate reachable.

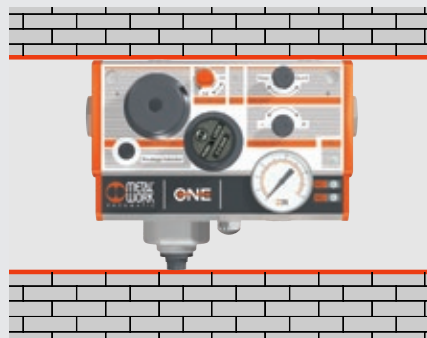

No clearance is required above and below it to make adjustments or change the filter or other components. The actual space occupied is thus further reduced.

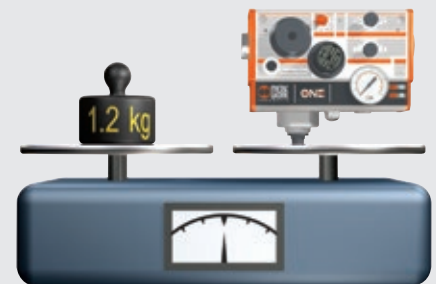

It weighs slightly more than one kilo instead of the 4 to 8 kilos of conventional units.

EASY ADJUSTMENTS AND LITTLE MAINTENANCE

The entire user interface is at the front, which means that everything is visible and easy to reach. All the adjustments are made using the push-lock knobs (no need for wrenches or screwdrivers), thus preventing accidental operations or manoeuvres.

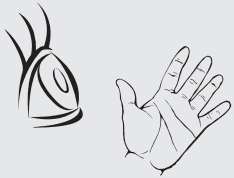

CONFIGURABILITY

Considering that ONE is reduced in size but highly performing, and it can integrate tenths of functions, a single unit can cover the entire range of applications, with cut-clear advantages in terms of standardisation and reduction of the number of codes handled and goods in stock. With a single size there are thousands of different configurations. For example, there is choice between 1/4", 3/8", 1/2", 3/4" or 1" threaded ports, manual and/or electric on-off or progressive valves, etc. The customer decides the configuration he wants and creates the code, using the key-to-coding table shown below in this catalogue. He will receive the unit he wants marked with its code and the correct pneumatic diagram.

WHAT YOU CAN SEE FROM THE OUTSIDE

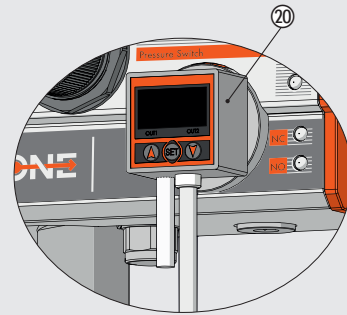
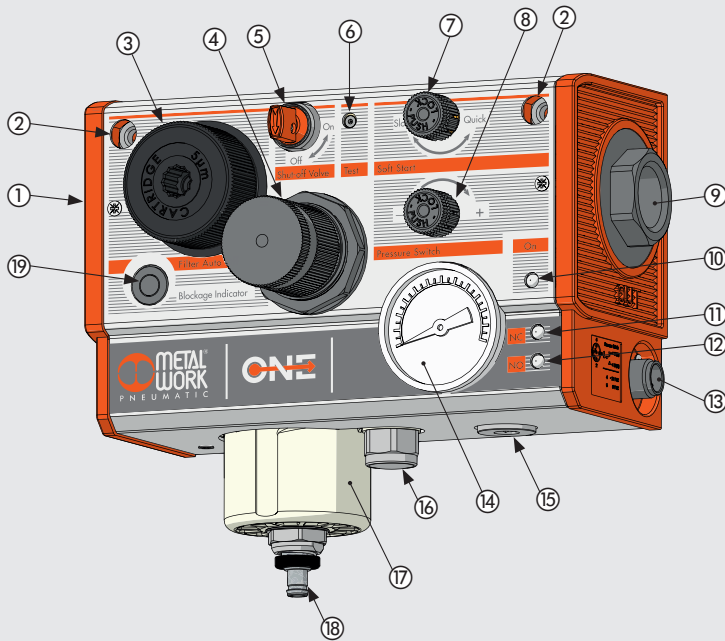

- ① Air intake, with swivel threaded port
- ② Fixing hole
- ③ Access to filter cartridge
- ④ Pressure regulation
- ⑤ Shut-off valve (manual)
- ⑥ Manual override (shut-off valve electrical)
- ⑦ Soft start valve regulation
- ⑧ Switching pressure regulation of the analog pressure switch
- ⑨ Air outlet, with swivel threaded port
- ⑩ LED signalling unit ON
- ⑪ LED signalling pressure below the value set on analog pressure switch
- ⑫ LED signalling pressure over the value set on analog pressure switch
- ⑬ 5-pin M12x1 electrical connector
- ⑭ Pressure gauge
- ⑮ 1/4" air intake. Another regulated air intake and a filtered non-regulated air intake are situated on the top
- ⑯ Air exhaust with a 1/4" silencer
- ⑰ Condensate tank
- ⑱ Condensate drain
- ⑲ Clogged filter signal
- ⑳ Digital pressure switch

THREADED PORTS



- The threaded ports at the air intake and outlet are the swivel type to facilitate coupling with the supply and delivery pipes. In this way, the unit can be mounted or removed without dismantling the pipes.
- A range of 5 different threads, 1/4", 3/8", 1/2", 3/4" and 1" is also available.
- The thread for the supply pipe may differ from that of the delivery one.

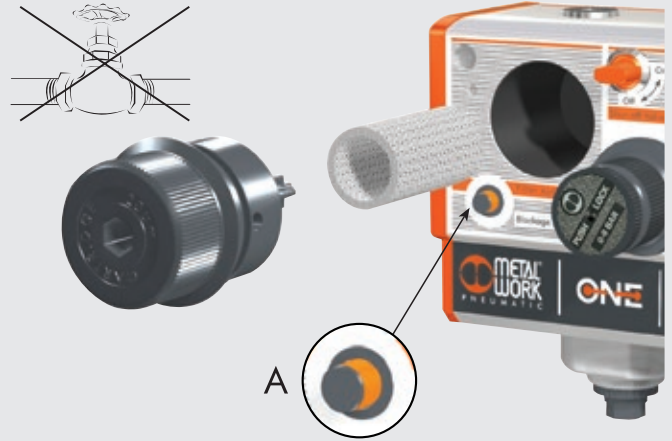

- If the filter gets so clogged up that it causes an excessive drop in pressure as the air passes through, the optical filter blockage indicator will project (see detail A) to indicate that the filter cartridge must be replaced.
- The cartridge can be replaced by unscrewing a plug at the front. This system is functional and, unlike conventional filters, does not require manoeuvring space below the unit.
- An automatic stop on-off valve is incorporated in the unit: when the filter plug is unscrewed, the valve closes automatically. This means there is not need to a tap upstream and there is no risk of the plug being ejected violently.

CONDENSATE DRAIN

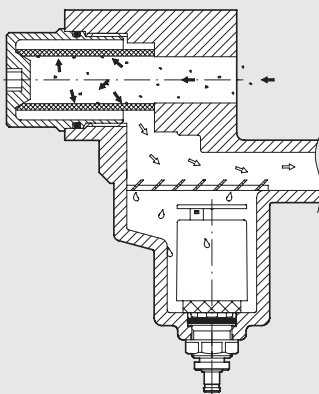

- The condensate drain is located downstream of the filter and thus uses cleaner air. This prevents the known problem of air leaks due to the deposit of dirt on the condensate discharge valve.
- You can request ONE with two types of condensate drain:
 - semi-automatic, type RMSA
 - automatic, of the floating type RA

SINGLE AIR EXHAUST



The air in the circuit is relieved via one outlet situated below the unit and fitted with silencer. If you want to convey air relief to prevent the emission of polluted air into the atmosphere, you can replace the silencer and install a fitting. (a pipe with a diameter of at least 6 mm is recommended)
 Next to the air outlet there is the condensate drain, which in the RA version conveys the draining by inserting the pipe having internal diameter 6 mm in the lower port.

SUPPLEMENTARY PORTS



In addition to the main outlet, there are three supplementary air ports with a 1/4" thread.

- one for filtered non-regulated air (A) for use, for example, with a compressed air gun.
- two for filtered regulated air (B).

The unit comes complete with supplementary plugged ports for use with A7 fittings.

PANEL MOUNTING



ONE can be mounted inside the guard of the machine leaving only the front visible. This is a considerable advantage in terms of functionality and aesthetics as the user interface is entirely at the front. Among the accessories to be ordered separately, there is the kit of brackets for panel mounting.

ELECTRICAL CONNECTION



A standard five-pin M12x1 connector, with IP65 protection is used for the opening solenoid valve and the pressure switch.

One cable only is required, thus improving reliability and reducing wiring times.

SOFT START VALVE

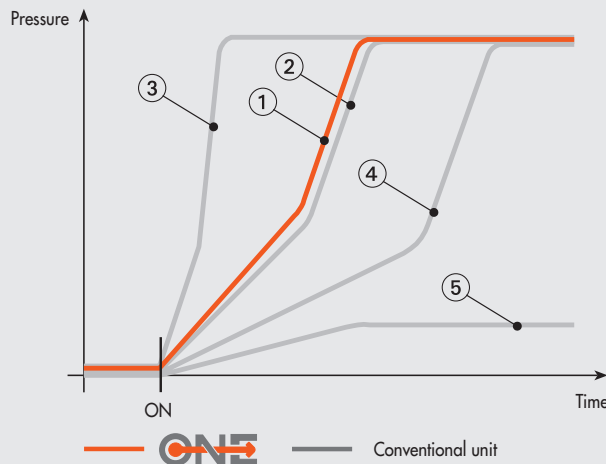

- ① Regulation for: **ONE** does not change with flow rate!
- ② Initial regulation of conventional unit
- ③ Low flow rate: activation too abrupt
- ④ High flow rate: activation too slow
- ⑤ Even higher flow rate: never cuts in!

The soft start valve is an absolutely innovative feature among the functions provided by ONE. Soft start valve available from the trade are generally based on the principle of leaving the passage of a small amount of air until the downstream pressure reaches a set value, and then opening the passage fully. In this way, the rate at which the pressure increases depends on the flow rate of the utilities, which often feature a continuous flow rate, for example a blow, and thus the starter can hardly activate. The solution offered by One is such that the pressure increases gradually and it is independent of the flow rate of the utilities. Pressure increase can be regulated precisely via the knob at the front. Another piece of news, among the several possible configurations you can have the soft start valve operated by the manual V3V

SPECIFICATIONS

TECHNICAL DATA		1/4"	3/8"	1/2"	3/4"	1"
Flow rate at 6.3 bar (0.63 MPa; 91 psi) ΔP 0.5 bar (0.05 MPa; 7 psi)	Nl/min	2200	2900		3600	
	scfm	78	102		127	
Flow rate at 6.3 bar (0.63 MPa; 91 psi) ΔP 1 bar (0.1 MPa; 14 psi)	Nl/min	2400	3300		4000	
	scfm	85	116		141	
Flow rate on discharge at 6 bar (0.6 MPa; 87 psi)	Nl/min			1600		
	scfm			56		
1/4" port flow rate of non-regulated filtered air at 6.3 bar (0.63 MPa; 91 psi) ΔP 1 bar	Nl/min			1800		
	scfm			64		
Flow rate of each supplementary 1/4" filtered and regulated air port at 6.3 bar (0.63 MPa; 91 psi) ΔP 1 bar *	Nl/min			2400		
	scfm			85		
Fluid		Compressed air				
Setting range	bar	0.5 to 2; 0.5 to 4; 0.5 to 8				
Degree of filtration	µm	5 (yellow) or 20 (white)				
Operating pressure range	bar	10				
	MPa	1				
	psi	145				
Operating temperature range	°C	-10 to 50				
	°F	-14 to 122				
Class of protection		IP 65 with connector				
Weight	kg	From 1.15 to 1.25 according to configurations				
Wall fixing (max. panel thickness 10 mm)		Front, with M5x75 screws or back, with M6x70 screws The screws are included in the supply				
Mounting position		Vertical				
Direction of flow		From left to right				
Compatibility with oils		See chapter Z1				
Solenoid valve						
Insulation class		F155				
Switching time		100% ED				
Electrical connector		M12x1, 5-PIN 90°, according to CEI IEC 60947-5-2				
Power	W	3/0.3				
Voltage	V	24 VDC ± 10%				
Analog pressure switch						
Pressure interval settable on the pressure switch	bar	0.5 to 10				
Pressure switch hysteresis (not adjustable)	bar	bar 0.4 to 0.8 (see diagram)				
Maximum pressure switch current	A	0.5				
Maximum pressure switch voltage	V	3 to 30 AC/DC				
Pressure switch contacts		Normally open (NO) and normally closed (NC)				
Number of switching		5x10 ⁶				
Digital pressure switch series 600		See page C6.22				

* Total flow rate from two supplementary outlets and the main one cannot exceed 4000 Nl/min at 6.3 bar with ΔP=1

WIRING DIAGRAM M12 CONNECTOR

Version with solenoid valve and analog pressure switch

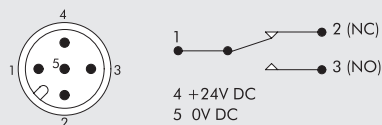

Version with analog pressure switch

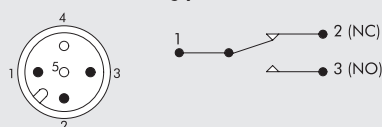

Version with solenoid valve

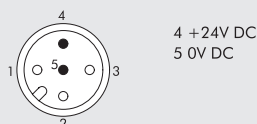

DIGITAL PRESSURE SWITCH WIRING DIAGRAM

PNP output with cable 2 m

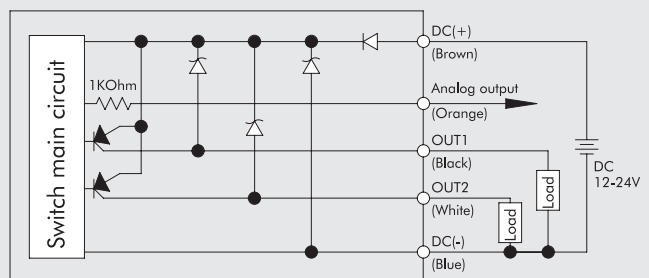

PNP output with M12 connector

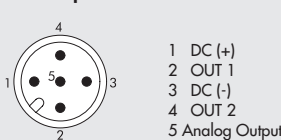

ANALOG PRESSURE SWITCH WIRING DIAGRAM

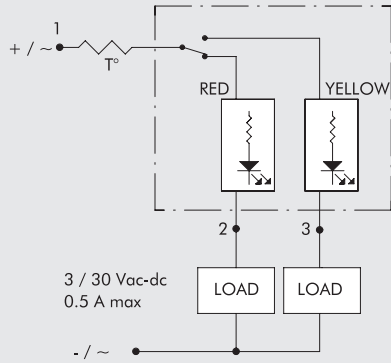

ANALOG PRESSURE SWITCH HYSTERESIS GRAPH

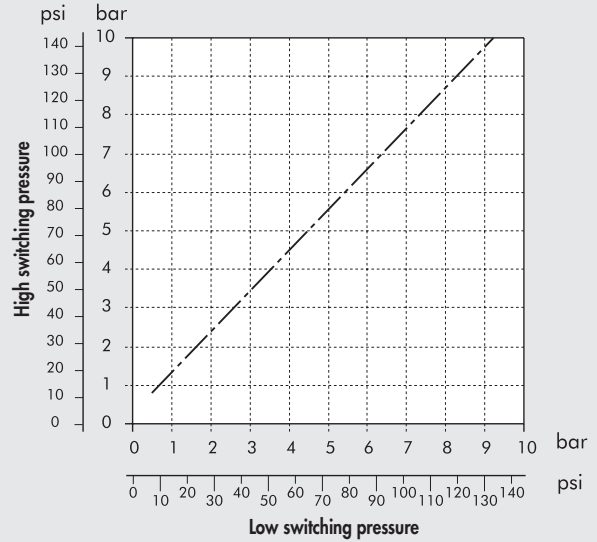

FLOW CHARTS

1/4"

Pm = 8 bar - 0.8 MPa - 116 psi
Preset pressure

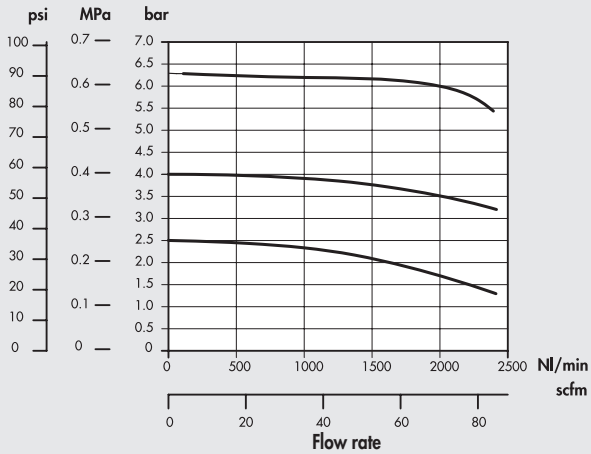

3/8"

Pm = 8 bar - 0.8 MPa - 116 psi
Preset pressure

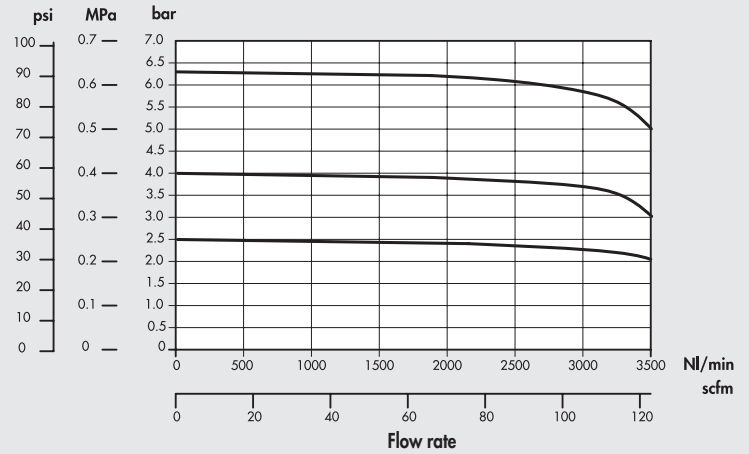

1/2" - 3/4" - 1"

Pm = 8 bar - 0.8 MPa - 116 psi
Preset pressure

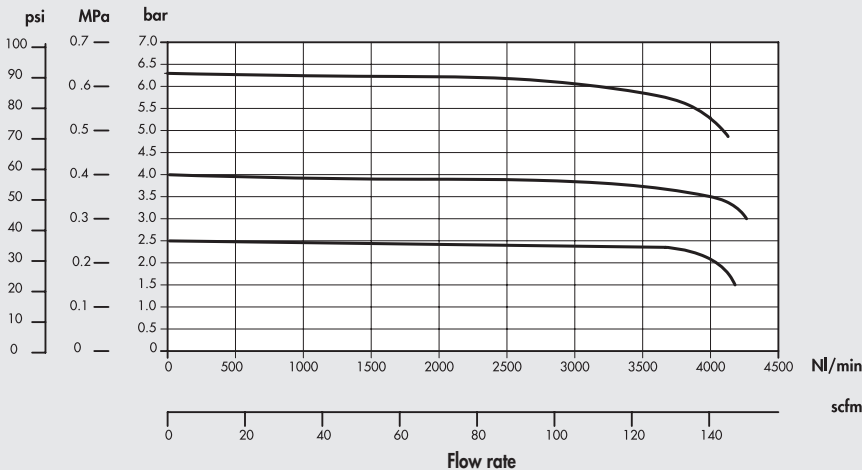

DIMENSIONS

STANDARD VERSION

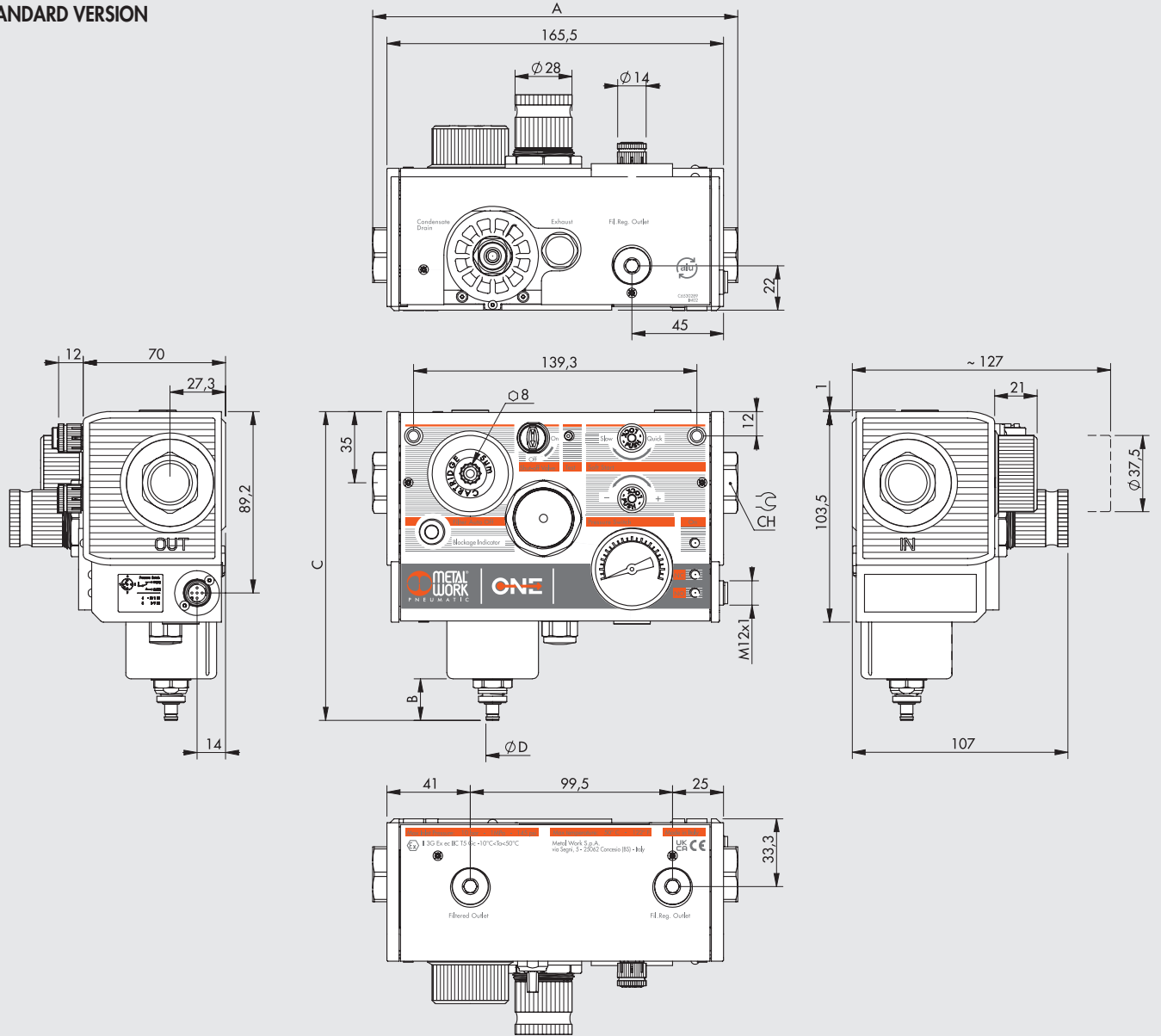

WITH DIGITAL PRESSURE SWITCH VERSION

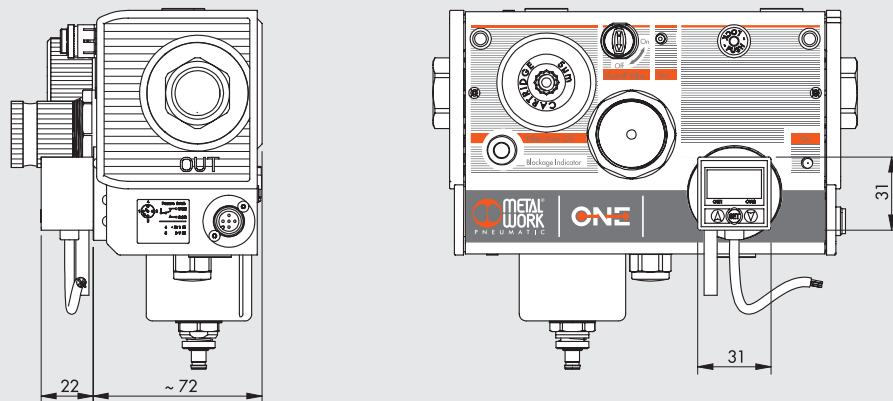

	1/4"	3/8"	1/2"	3/4"	1"		RA	RMSA	
A		180			195	B	20.4	16.4	
CH	19	22	27	32	36	C	152	148	
						Ø D	For pipe internal diameter 6 mm		15

EXTERNAL DESIGN

You can get thousands of different configurations. The external design differs according on the versions chosen.

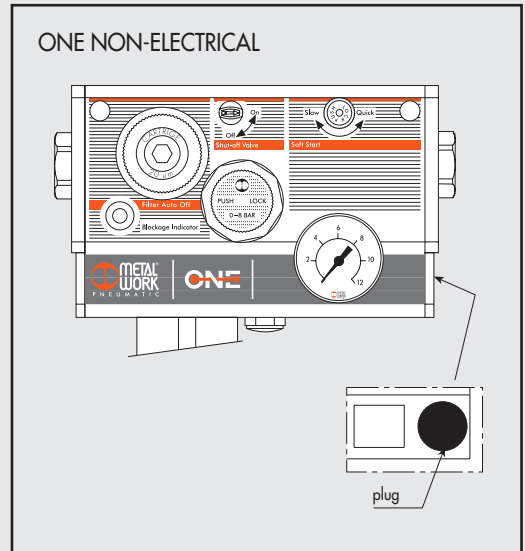
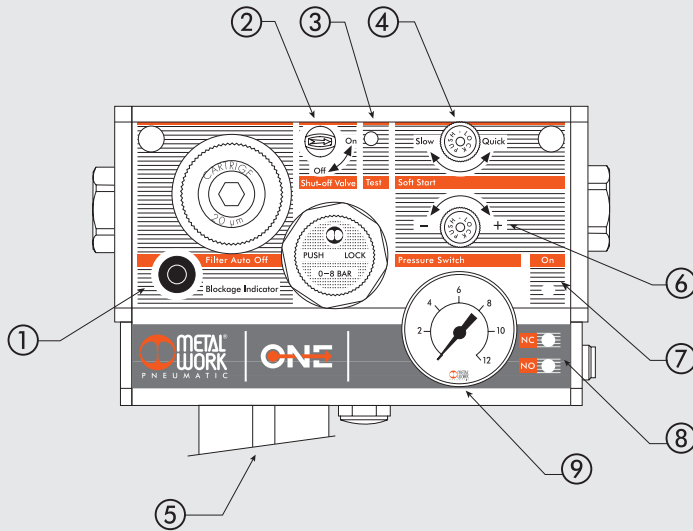

<p>CLOGGED FILTER SIGNAL ①</p> <p>PRESENT</p> <p>NOT PRESENT</p>	<p>V3V MANUAL ②</p> <p>STANDARD</p> <p>LOCKABLE</p> <p>NOT PRESENT</p>	<p>V3V ELECTRICAL</p> <p>PRESENT</p> <p>NOT PRESENT</p> <p>in some versions holes are present</p> <p>in other configurations the cover has no holes</p>	<p>SOFT START VALVE ④</p> <p>PRESENT</p> <p>NOT PRESENT</p>
<p>CONDENSATE DRAIN ⑤</p> <p>AUTOMATIC (RA)</p> <p>RMSA</p>	<p>ANALOG PRESSURE SWITCH</p> <p>PRESENT</p> <p>NOT PRESENT</p> <p>in some versions holes are present</p> <p>in other configurations the cover has no holes</p>	<p>READING OF PRESSURE GAUGE ⑨</p> <p>DIGITAL PRESSURE SWITCH</p>	

UNITS
ONE: SPECIFICATIONS

HOW TO ORDER

ORDERING CODES

You can choose among numerous variants and options. The product code so personalised is made up by compiling the diagram below. The code so compiled must be specified on the order. A label showing the code and its pneumatic diagram is affixed onto the product.

	A	B	C	D	E	F	G	H	I	L
	ONE electric or ONE non-electric	Air intake	Degree of filtration	Clogged filter signal	Condensate drain	Pressure regulation	Valves	Pressure switch	Air outlet	Miscellaneous, special version
EXAMPLE	54	3	2	1	1	2	7	1	3	0 0
53	ONE non-electric	1 1/4"	2 20 µm	0 NO	0 RMSA	2 0.5-2 bar	0 None	0 NO	1 1/4"	00 Standard
54	ONE electric *	2 3/8"	5 5 µm	1 YES	1 Automatic (RA)	4 0.5-4 bar	1 V3V manual	1 YES Analog	2 3/8"	
		3 1/2"				8 0.5-8 bar	2 V3V manual with padlock	2 YES Digital with cable 2 m	3 1/2"	
		4 3/4"					3 V3V manual and soft start valve	3 YES With M12 connector	4 3/4"	
		5 1"					4 V3V manual with padlock and soft start valve		5 1"	
							5 V3V manual and V3V electric			
							6 V3V manual with padlock and V3V electric			
							7 V3V manual and APR electric			
							8 V3V manual with padlock and APR electric			
							9 only V3V electric			
							A only APR electric			

* a pressure switch version and/or electric V3V and/or electric progressive actuator.

● **NB: versions valid only for the electric ONE (code 54...)**

- A ONE electric or non-electric**
ONE non-electric: there is no component actuated electrically: select code 53. In this case, the unit comes without any M12x1 connector, LED, pressure switch, or electric V3V.
ONE electric: there is at least one component actuated electrically, and thus the pressure switch and/or electric V3V (and/or the electrical soft start valve) select code 54. In this case, the unit comes with the M12x1 connector and 3 LEDs. Only the LEDs associated with the functions installed will be active.
- B Air intake**
 There are 5 different gas cylindrical threads: 1/4", 3/8", 1/2", 3/4" and 1".
- C Degree of filtration**
 A cartridge with a degree of filtering of 5 µm (yellow) or 20 µm (white) is available. This value is marked on the plug.
- D Clogged filter signal**
 If the filter gets so clogged up that it causes an excessive drop in pressure as the air passes through, the orange indicator will project from the body by a few millimetres.
- E Condensate drain**
RMSA: the condensate is drained out automatically only by relieving the air pull the knurled knob for having the same result.
Automatic (RA): a floating system that automatically drains the condensate out whenever the level of water in the bowl reaches the set value.
- F Pressure regulation**
 There are three possible regulation fields.
 The value is marked on the regulation knob.
- G Valves**
 There are 11 different combinations. The electric valves are clearly selectable only if the initial code is 54, i.e. ONE electric.
- **0 - No valves present**
 - **1 - V3V manual:** is a 3/2 valve that in a set position allows the air to flow and in the other it closes the passage and discharges the pressure downstream.
 - **2 - V3V manual with padlock:** like the previous one, with the possibility of inserting a padlock (included in the supply with 2 keys) in the valve closed position.
 - **3 - V3V manual and soft start valve:** when the manual V3V valve is operated, the pressure starts to increase slowly, with a fine adjustable ramp, and when it reaches about 30-40% of the set value, the valve opens completely and the pressure rises to the set value.
 - **4 - V3V manual with padlock and soft start valve:** like the previous, with the padlock device on the manual V3V in "OFF" position.
 - **5 - V3V manual and V3V electric:** two V3V in series are present, one is manual the other electrical. By operating both the valve the air flow is allowed. If one or two are switched OFF, the air downstream is relieved. The electrical one can also be operated manually by keeping pushed the "TEST" button
 - **6 - V3V manual with padlock and V3V electric:** like the previous, with the padlock device in "OFF" position.
 - **7 - V3V manual and APR electric:** One manual V3V and one soft start valve are present. When both are operated, the pressure starts to increase slowly, with a fine adjustable ramp, and when it reaches about 30-40% of the set value, the valve opens completely and the pressure rises to the set value.
 - **8 - V3V manual with padlock and APR electric:** like the previous, with the padlock device on the manual V3V in "OFF" position.
 - **9 - V3V electric:** It's present only the electrical V3V. The valve will open if it is powered on. When the power supply is switched off, the valve closes and air downstream is relieved. The valve can also be operated manually by keeping pushed the test button.
 - **A - APR electric:** It's present only the electric soft start valve. When it is powered ON, the pressure starts to increase slowly, with a fine adjustable ramp, and when it reaches about 30-40% of the set value, the valve opens completely and the pressure rises to the set value.
- H Analog pressure switch**
 The pressure switch has a switching contact, which means you can have a normally-open signal or a normally-close signal. It is also connected to the NC and NO LEDs which come on if the actual pressure is less or greater than the set pressure, respectively. The LEDs only come on if an electric charge is connected to them.
Digital pressure switch
 The digital pressure switch allows both the transmission of electrical pressure signals and the instant display of pressure. Two digital outputs, which can be set according to the two pressure values reached, are available. An analogue output of a voltage proportional to the pressure reading is also available. The values are clearly displayed on a LED video and different parameters can be entered from the keypad. Hysteresis can be adjusted and the unit of measurement for pressure can be modified.
- I Air outlet**
 Five different gas cylindrical threads are available: 1/4", 3/8", 1/2", 3/4" and 1". It is possible to choose a thread other than the one on the inlet port.
- L Free positions for special executions.**

PANEL MOUNTING BRACKETS

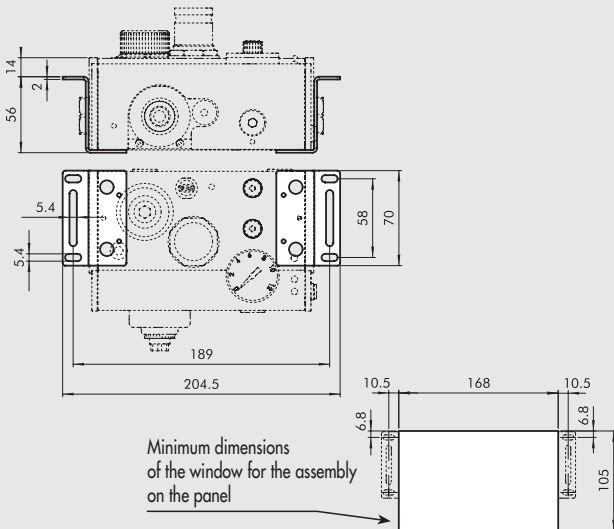

Code	Description
9200702	Kit – panel mounting brackets N.B.: fixing screws included

COVER DISASSEMBLY WRENCH

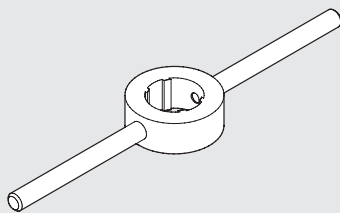

Code	Description
9170401	Cover disassembly wrench

SECURITY KNOB

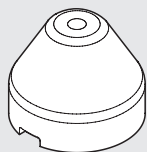

Code	Description
9200703	Security knob apr/pressure switch

NOTE: Pull outwards to remove the knob from the APR/pressure switch on the unit. Insert the security knob and regulate the APR/ pressure switch. Then press the handle firmly to lock it in position. If the APR/pressure switch needs to be reset, remove the security knob by forcing it laterally with a screwdriver.

STRAIGHT CONNECTOR

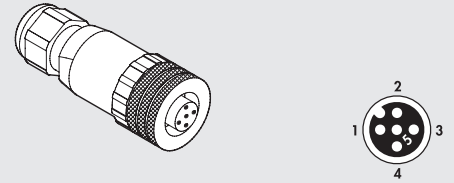

Code	Description
W0970513001	5-PIN M12X1 straight connector

STRAIGHT CONNECTOR WITH WIRE

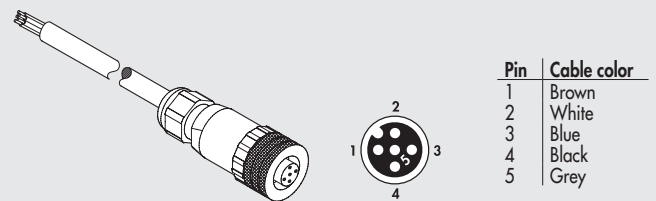

Code	Description
W0970513002	5-PIN M12X1 straight connector with wire L = 5 m

Pin	Cable color
1	Brown
2	White
3	Blue
4	Black
5	Grey

90° CONNECTOR

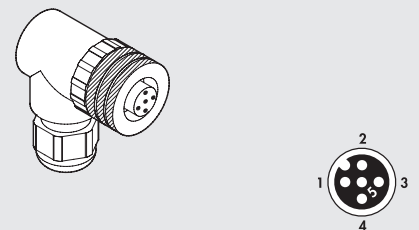

Code	Description
W0970513003	M12X1 5-PIN 90° connector

90° CONNECTOR WITH WIRE

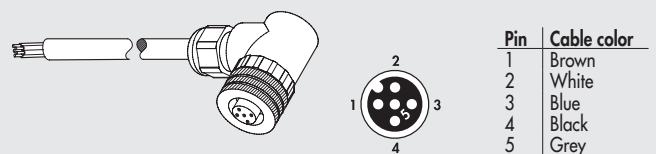

Code	Description
W0970513004	M12X1 5-PIN 90° connector with wire L = 5 m

Pin	Cable color
1	Brown
2	White
3	Blue
4	Black
5	Grey

PRESSURE GAUGE

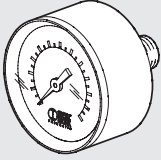

Code	Description
9700106	M 39 1/8 0-4
9700107	M 39 1/8 0-12

THREADED PORT

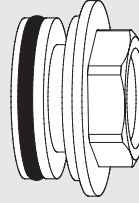

Code	Description
9232001	1/4" spare thr. port for ONE
9232002	3/8" spare thr. port for ONE
9232003	1/2" spare thr. port for ONE
9232004	3/4" spare thr. port for ONE
9232005	1" spare thr. port for ONE

FILTER ELEMENT

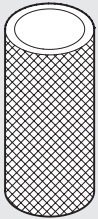

Code	Description
9251720	Spare filter element 5 µm for ONE
9251721	Spare filter element 20 µm for ONE

FILTER PLUG WITH FILTER ELEMENT

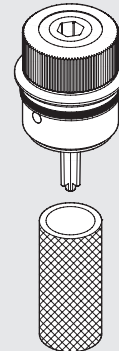

Code	Description
9251723	Spare plug + filter element 5 µm ONE
9251724	Spare plug + filter element 20 µm ONE

PILOT REGULATOR

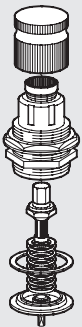

Code	Description
9250820	Spare pilot reg. 0.5 to 2 bar for ONE
9250821	Spare pilot reg. 0.5 to 4 bar for ONE
9250822	Spare pilot reg. 0.5 to 8 bar for ONE

POPPET

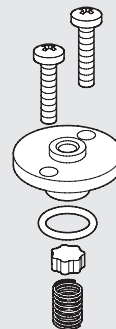

Code	Description
9250707	Spare poppet for ONE

