

Skillair® PADLOCKABLE REGULATOR



The padlockable regulator has a pin with a hole in it that projects from the top of the knob. When the knob is in the push-lock position, the padlock can be inserted in the hole, preventing the knob from being operated. A padlock and two keys are supplied with the regulator.

The new Skillair® regulator uses a rolling diaphragm which gives a much better performance than the flat version.

Advantages of this system:

- Increased stroke, increased valve opening and hence higher flow rate.
- Decreased dynamic and inrush friction; prompt, more sensitive operation.
- Reduced working stress and hence longer life allowing the use of thinner diaphragms (0.45 mm versus 1.5 mm for a flat one) which increases regulator sensitivity and prompt action.
- Increased accuracy in maintaining the set pressure with both variable flow rates and different feed pressures.
- Downstream overpressures relieved quickly.

Refer to the regulator for technical data and flow curves.



COMPONENTS

- ① Technopolymer body
- ② Zamak end plate
- ③ Technopolymer knob
- ④ Technopolymer bell
- ⑤ Nickel-plated OT58 brass adjusting screw
- ⑥ OT58 brass scroll
- ⑦ Steel adjusting spring
- ⑧ Technopolymer ring nut
- ⑨ Rolling diaphragm
- ⑩ NBR relieving gaskets
- ⑪ OT58 brass stem
- ⑫ Valve with NBR vulcanized gasket
- ⑬ Stainless steel valve spring
- ⑭ Technopolymer plug
- ⑮ NBR gaskets
- ⑯ Padlock

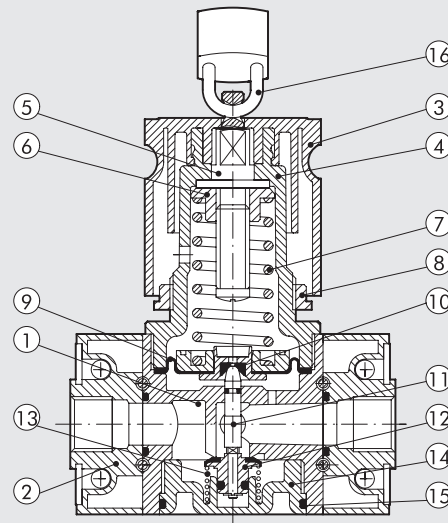

DIMENSIONS

	REG 100 KEY		REG 200 KEY			REG 300 KEY		
Threaded port G	1/4"	3/8"	1/4"	3/8"	1/2"	1/2"	3/4"	1"
A	78		93.5			110		
B	95 to 98		123 to 125			145 to 148		
C	50		63			72		
D	43		55			65		
E	63		78.5			92		
F	26		36			42		
H	30 x 1.5		40 x 1.5			48 x 1.5		
I	21.5		27.5			32.5		
L	Hole for M4 screws		Hole for M5 screws			Hole for M5 screws		
M	43		55.5			65		
N	101		127			151		
O (pressure gauge port)	1/8"		1/8"			1/8"		
P	46		58			69		

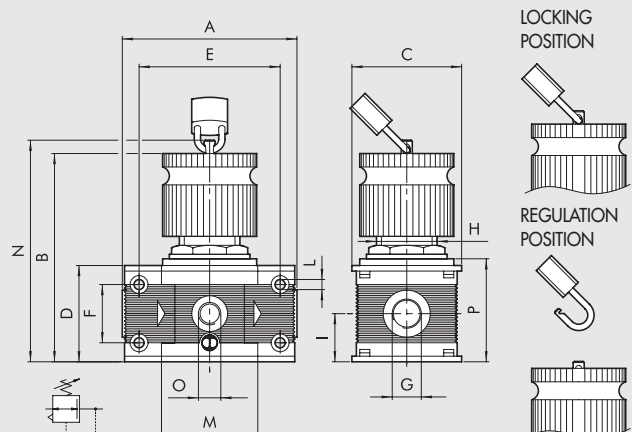

SYNOPTIC, SIZES AND VERSIONS

REG ELEMENT	100 SIZE	KEY TYPE	1/4 THREADED PORT	02 SETTING RANGE
REG = Regulator	100	KEY = Padlockable	1/4	02 = 0 to 2 bar 04 = 0 to 4 bar 08 = 0 to 8 bar 012 = 0 to 12 bar
	200		3/8	
	300		1/4 3/8 1/2 1/2 3/4 1	

ORDERING CODES

Code	Description	Code	Description	Code	Description
Skillair® 100 PADLOCKABLE REGULATOR		Skillair® 200 PADLOCKABLE REGULATOR		Skillair® 300 PADLOCKABLE REGULATOR	
3210001A	REG 100 KEY 02 without end plates	3410001A	REG 200 KEY 02 without end plates	4410000A	REG 300 KEY 02 without end plates
3210002A	REG 100 KEY 04 without end plates	3410002A	REG 200 KEY 04 without end plates	4410001A	REG 300 KEY 04 without end plates
3210003A	REG 100 KEY 08 without end plates	3410003A	REG 200 KEY 08 without end plates	4410002A	REG 300 KEY 08 without end plates
3210004A	REG 100 KEY 012 without end plates	3410004A	REG 200 KEY 012 without end plates	4410003A	REG 300 KEY 012 without end plates
3210001	REG 100 KEY 1/4 02	3410001	REG 200 KEY 1/4 02	4410000	REG 300 KEY 1/2 02
3210002	REG 100 KEY 1/4 04	3410002	REG 200 KEY 1/4 04	4410001	REG 300 KEY 1/2 04
3210003	REG 100 KEY 1/4 08	3410003	REG 200 KEY 1/4 08	4410002	REG 300 KEY 1/2 08
3210004	REG 100 KEY 1/4 012	3410004	REG 200 KEY 1/4 012	4410003	REG 300 KEY 1/2 012
3310001	REG 100 KEY 3/8 02	3510001	REG 200 KEY 3/8 02	4510000	REG 300 KEY 3/4 02
3310002	REG 100 KEY 3/8 04	3510002	REG 200 KEY 3/8 04	4510001	REG 300 KEY 3/4 04
3310003	REG 100 KEY 3/8 08	3510003	REG 200 KEY 3/8 08	4510002	REG 300 KEY 3/4 08
3310004	REG 100 KEY 3/8 012	3510004	REG 200 KEY 3/8 012	4510003	REG 300 KEY 3/4 012
		3610001	REG 200 KEY 1/2 02	4610000	REG 300 KEY 1 02
		3610002	REG 200 KEY 1/2 04	4610001	REG 300 KEY 1 04
		3610003	REG 200 KEY 1/2 08	4610002	REG 300 KEY 1 08
		3610004	REG 200 KEY 1/2 012	4610003	REG 300 KEY 1 012

UNITS

Skillair® PADLOCKABLE REGULATOR

Skillair® ACCESSORIES

MOUNTING BRACKET FOR REG.

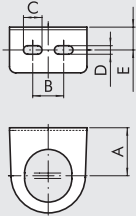

Code	Description
9200701	SF100- BIT-ND1/4
9400701	SF200-ND-3/8 1/2
9400702	SF300

Code	A	B	C	D	E
9200701	32	20	12	5.5	14.2
9400701	42	40	12	5.5	15
9400702	48	49	12	5.5	17

PRESSURE GAUGES

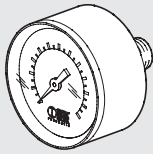

Code	Description
9700101	M 40 1/8 012
9700102	M 40 1/8 04
9800101	M 50 1/8 012
9800102	M 50 1/8 04
9900101	M 63 1/4 012

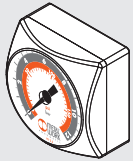

9700109	M 40x40 1/8 04
9700110	M 40x40 1/8 012

COIL 22 mm FOR APR AND V3V ELPN

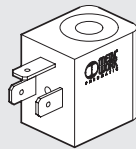

Code	Description
W0215000151	Coil 22 Ø 8 BA 2W-12VDC
W0215000101	Coil 22 Ø 8 BA 2W-24VDC
W0215000111	Coil 22 Ø 8 BA 3.5VA-24VAC
W0215000121	Coil 22 Ø 8 BA 3.5VA-110VAC
W0215000131	Coil 22 Ø 8 BA 3.5VA-220VAC

Electrical connection DIN 43650 B-IND

COIL 22 mm FOR APR AND V3V ELPN

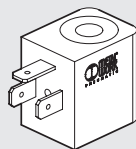

Code	Description
W0215000251	Coil 22 Ø 8 BA 2W-12VDC UR
W0215000201	Coil 22 Ø 8 BA 2W-24VDC UR
W0215000211	Coil 22 Ø 8 BA 3.5VA-24VAC UR
W0215000221	Coil 22 Ø 8 BA 3.5VA-110VAC UR
W0215000231	Coil 22 Ø 8 BA 3.5VA-220VAC UR

Electrical connection DIN 43650 B-IND



COIL 30 mm FOR APR AND V3V ELPN

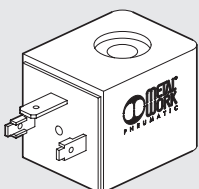

Code	Description
W0210010100	Coil 30 Ø 8 2W-24VDC
W0210011100	Coil 30 Ø 8 3.5VA-24VAC 50/60 HZ
W0210012100	Coil 30 Ø 8 3.5VA-110VAC 50/60 HZ
W0210013100	Coil 30 Ø 8 3.5VA-220VAC 50/60 HZ

Electrical connection DIN 43650 - A

COIL 30 mm FOR CDV CDML LUBRICATOR

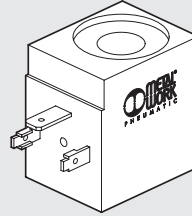

Code	Description
W0216001001	Coil 30 Ø13 10W-24VDC
W0216001011	Coil 30 Ø13 13VA-24VAC 50/60HZ
W0216001021	Coil 30 Ø13 13VA-110VAC 50/60HZ
W0216001031	Coil 30 Ø13 13VA-220VAC 50/60HZ

Electrical connection DIN 43650 - A

KIT FOR COIL EEXM (FOR V3V-APR-LUB)

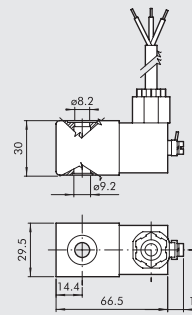

Code	Description
0227606913	Kit for coil 30 24 VDC EEXMT5 cable 3 m
0227606915	Kit for coil 30 24 VDC EEXMT5 cable 5 m
0227608013	Kit for coil 30 24 VAC EEXMT5 cable 3 m
0227608015	Kit for coil 30 24 VAC EEXMT5 cable 5 m
0227608023	Kit for coil 30 110 VAC EEXMT5 cable 3 m
0227608025	Kit for coil 30 110 VAC EEXMT5 cable 5 m
0227608033	Kit for coil 30 230 VAC EEXMT5 cable 3 m
0227608035	Kit for coil 30 230 VAC EEXMT5 cable 5 m

According to Atex 2014/34/EU rule,
 ⓧ II 2G Ex mb IIC T4/T5 Gb
 ⓧ II 2D Ex tb IIIC T130/T95 °C IP66 Db
 N.B.: Supplied complete with adapter for Ø8 mm sleeve

ELECTRIC CONNECTOR 22 mm FOR COILS DIN 43650 B-IND

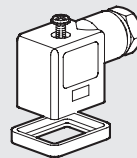

Code	Description
W0970510011	Connector standard
W0970510012	Connector 22 LED 24V
W0970510013	Connector 22 LED 110V
W0970510014	Connector 22 LED 220V
W0970510015	Connector 22 LED VDR 24V
W0970510016	Connector 22 LED VDR 110V
W0970510017	Connector 22 LED VDR 220V
W0970510070	Connector 22 ATEX II 2 GD

ELECTRIC CONNECTOR 30 mm FOR COILS DIN 43650-A

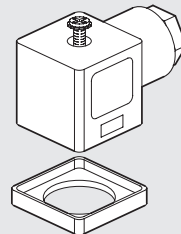

Code	Description
W0970520033	Connector 30 STD
W0970520034	Connector 30 LED 24V
W0970520035	Connector 30 LED 110V
W0970520036	Connector 30 LED 220V
W0970520037	Connector 30 LED VDR 24V
W0970520038	Connector 30 LED VDR 110V
W0970520039	Connector 30 LED VDR 220V

M8 STRAIGHT CONNECTOR WITH CABLE FOR PRESSURE SWITCHES

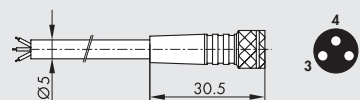

Pin	Cable color
1	Brown
3	Blue
4	Black

Code	Description
02400A0100	M8 female 3 PIN HIGH FLEX CL6 connector with cable L = 1 m
02400A0250	M8 female 3 PIN HIGH FLEX CL6 connector with cable L = 2.5 m
02400A0500	M8 female 3 PIN HIGH FLEX CL6 connector with cable L = 5 m
02400A1000	M8 female 3 PIN HIGH FLEX CL6 connector with cable L = 10 m

Very flexible cables, class 6 according to IEC 60228

M8 ADAPTER CABLE FOR CONNECTING THE PRESSURE SWITCH TO THE EB 80 E CM DIGITAL INPUTS MODULE

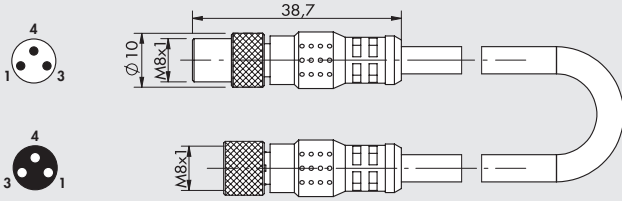

Code	Description
0240010501	M8-M, M8-F 3-pole adapter with cable L = 0.3 m

Note: Can be used to connect the pressure switch to the module of digital INPUT 501 of the EB 80 valves, to the additional M8 INPUT module of the CM valves and to the Profibus-DP IP67 M8 input. Contact type NO (Normally open)

M8F	M8M	Function
pin 1	pin 1	Power supply +
pin 3	pin 2	Signal NO
pin 4	disconnect	

KIT COIL SIDE 22 IP65 (FOR V3V-APR-LUB)



Code	Description
0222100100	Kit for coils 22 - IP65

Improved IP65 protection, even after prolonged exposure to atmospheric agents. Applicable to valves with a technopolymer control.

CONNECTOR KIT FOR SKILLAIR CODE A

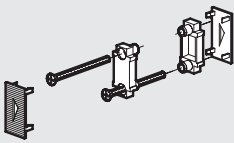

Code	Description
9230301	Connector kit 100
9330301	Connector kit 200
9430301	Connector kit 300
9630301	Connector kit 400

INPUT/OUTPUT END PLATE KIT

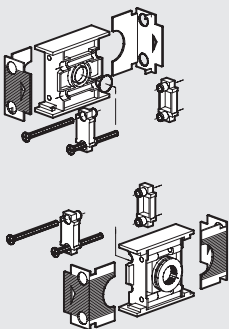

Code	Description
9230401	IN/OUT end plate kit 100 1/4
9330501	IN/OUT end plate kit 100 3/8
9330601	IN/OUT end plate kit 200 1/4
9330701	IN/OUT end plate kit 200 3/8
9330801	IN/OUT end plate kit 200 1/2
9430701	IN/OUT end plate kit 300 1/2
9530901	IN/OUT end plate kit 300 3/4
9531001	IN/OUT end plate kit 300 1
9631001	IN/OUT end plate kit 400 1
9631101	IN/OUT end plate kit 400 1 1/4
9631201	IN/OUT end plate kit 400 1 1/2
9631301	IN/OUT end plate kit 400 2

FILTER BOWL

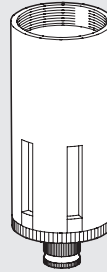

Code	Description
9253301	Spares TF 100 RMSA
9255301	Spares TF 100 SAC
9353301	Spares TF 200 RMSA
9355301	Spares TF 200 SAC
9453401	Spares TF 300 RA
9453301	Spares TF 300 RMSA
9653401	Spares TF 400 RA
9653301	Spares TF 400 RMSA

LUBRICATOR BOWL



Code	Description
9253501	Spares TL 100
9202503	Spares TL 100 CA
9202502	Spares TL 100 CD
9202501	Spares TL 100 ML
9353501	Spares TL 200
9302501	Spares TL 200 CA
9302503	Spares TL 200 CD
9302502	Spares TL 200 ML
9453501	Spares TL 300
9202401	Spares TL 300 CA
9202403	Spares TL 300 CD
9202402	Spares TL 300 ML
9653501	Spares TL 400
9653502	Spares TL 400 CA
9653504	Spares TL 400 CD
9653503	Spares TL 400 ML

FILTERING ELEMENTS

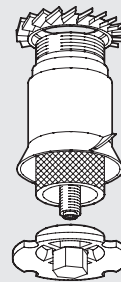

Code	Description
9251705	Spares FP 100 5
9251706	Spares FP 100 20
9251707	Spares FP 100 50
9351705	Spares FP 200 5
9351706	Spares FP 200 20
9351707	Spares FP 200 50
9451705	Spares FP 300 5
9451706	Spares FP 300 20
9451707	Spares FP 300 50
9651705	Spares FP 400 5
9651706	Spares FP 400 20
9651707	Spares FP 400 50

FILTERING/PURIFICATION ELEMENTS

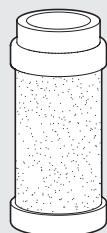

Code	Description
9251711	Spares FP DEP. 100
9351711	Spares FP DEP. 200
9451711	Spares FP DEP. 300
9651711	Spares FP DEP. 400

CARTRIDGE AC

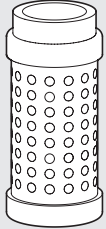

Code	Description
9251713	Spares cartridge 100 AC
9351713	Spares cartridge 200 AC
9451713	Spares cartridge 300 AC
9651712	Spares cartridge 400 AC

UPPER COVER FOR REGULATOR AND FR

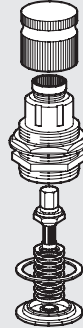

Code	Description
9250800	Spares CS 100 02
9250810	Spares CS 100 04
9250811	Spares CS 100 08
9250812	Spares CS 100 012
9350800	Spares CS 200 02
9350810	Spares CS 200 04
9350811	Spares CS 200 08
9350812	Spares CS 200 012
9450805	Spares CS 300 04
9450806	Spares CS 300 08
9450807	Spares CS 300 012
9450808	Spares CS 300 02

VENTURI LUBRICATOR DIAPHRAGM

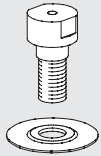

Code	Description
9252001	Spares MB 100 ND 1/4
9352001	Spares MB 200 ND 3/8-1/2
9452001	Spares MB 300
9652601	Spares MB 400

COMPLETE POPPET FOR REGULATORS

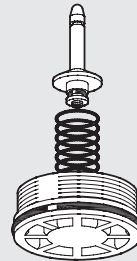

Code	Description
9250704	Spares OTR 100
9350704	Spares OTR 200
9450704	Spares OTR 300
9650704	Spares OTR 400

TRANSPARENT LUBRICATOR COVER

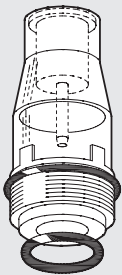

Code	Description
9251302	Spares CVL 100-200-300-400 BIT

COMPLETE POPPET FOR FR

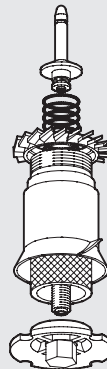

Code	Description
9250902	Spares OTFR 100 5
9250903	Spares OTFR 100 20
9250904	Spares OTFR 100 50
9350902	Spares OTFR 200 5
9350903	Spares OTFR 200 20
9350904	Spares OTFR 200 50
9450902	Spares OTFR 300 5
9450903	Spares OTFR 300 20
9450904	Spares OTFR 300 50

SPRINGS FOR REDUCERS AND FRs

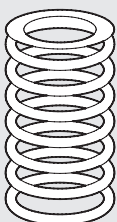

Code	Description
9250605	Spares MO 100 02
9250606	Spares MO 100 04
9250607	Spares MO 100 08
9250608	Spares MO 100 012
9350605	Spares MO 200 02
9350606	Spares MO 200 04
9350607	Spares MO 200 08
9350608	Spares MO 200 012
9450605	Spares MO 300 04
9450606	Spares MO 300 08
9450607	Spares MO 300 012
9450608	Spares MO 300 02

UPPER COVER DISASSEMBLY SPANNER

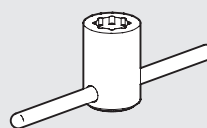

Code	Description
9220701	Spares cover spanner

REG AND FR VISUAL DOME DISASSEMBLY SPANNER

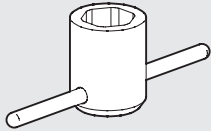

Code	Description
9220401	Spares dome dis. spanner 100
9323401	Spares dome dis. spanner 200
9420401	Spares dome dis. spanner 300

PROVISION FOR SOLENOID CONTROL TO CNOMO FOR APR-300

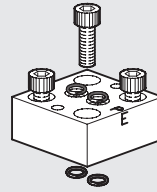

Code	Description
9454001	Spares PCE to Cnomo

POPPET DISASSEMBLY SPANNER (FOR REG.)

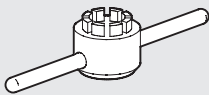

Code	Description
9220501	Spares R cap disass. WR. 100
9323501	Spares R cap disass. WR. 200
9420501	Spares R cap disass. WR. 300

PROVISION FOR MICRO SOLENOID CONTROL FOR APR-300

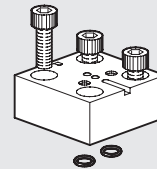

Code	Description
9453601	Spares PCE micro

POPPET DISASSEMBLY SPANNER (FOR FR)

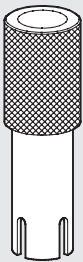

Code	Description
9220801	Spares FR cap disass. WR. 100
9320801	Spares FR cap disass. WR. 200
9420801	Spares FR cap disass. WR. 300

PROVISION FOR PNEUMATIC CONTROL FOR APR-300

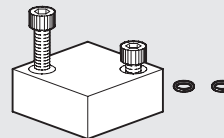

Code	Description
9453701	Spares PCP pneumatic

CAP DISASSEMBLY SPANNER

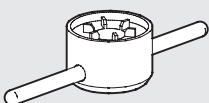

Code	Description
9220601	Spares cap disass. 100
9323601	Spares cap disass. 200
9420601	Spares cap disass. 300

CNOMO SOLENOID CONTROL FOR APR and V3V 300-400

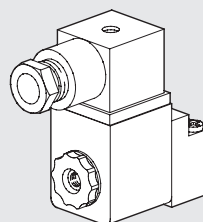

Code	Description
9453901	Spares CEC Cnomo 24CC
9453902	Spares CEC Cnomo 24V
9453903	Spares CEC Cnomo 110V
9453904	Spares CEC Cnomo 220V

**MICRO SOLENOID CONTROL FOR APR-300 and V3V 300
(NO MORE IN THE CATALOGUE)**

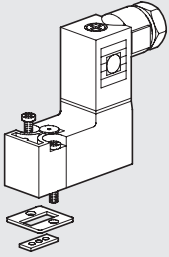

Code	Description
9453801	Spares CEM micro 24CC
9453802	Spares CEM micro 24V
9453803	Spares CEM micro 110V
9453804	Spares CEM micro 220V

INTERMEDIATE COVER PLATE

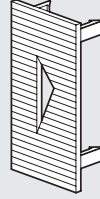

Code	Description
9152107	Spares intermediate cover plate 100
9152114	Spares intermediate cover plate 200
9152108	Spares intermediate cover plate 300
9152117	Spares intermediate cover plate 400

KEY-OPERATED V3V 400

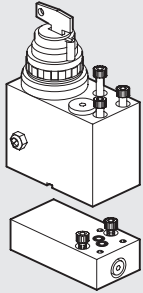

Code	Description
9455401	Spares kit C.C. 400

AUTOMATIC DRAIN (RA)

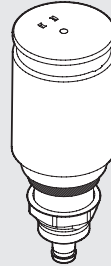

Code	Description
9000802	Spares RA automatic drain

MANUAL LOCKABLE V3V 400

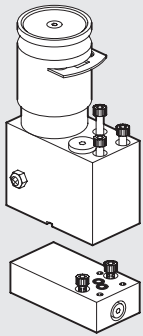

Code	Description
9455601	Spares kit lockable 400

AUTOMATIC DRAIN (SAC)



Code	Description
9000803	Spares SAC automatic drain

INPUT/OUTPUT COVER PLATE

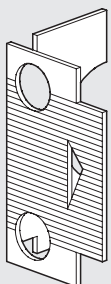

Code	Description
9152103	Spares OUTPUT cover plate 100
9152105	Spares INPUT cover plate 100
9152115	Spares OUTPUT cover plate 200
9152116	Spares INPUT cover plate 200
9152104	Spares OUTPUT cover plate 300
9152106	Spares INPUT cover plate 300
9152118	Spares OUTPUT cover plate 400
9152119	Spares INPUT cover plate 400

NOTES