

Vacuum Blocks VCBL-S6

For TV systems from SCM · Height 50 mm, 75 mm and 110 mm

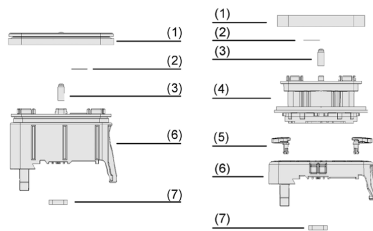

Vacuum Blocks VCBL-S6



System design Vacuum Blocks VCBL-S6

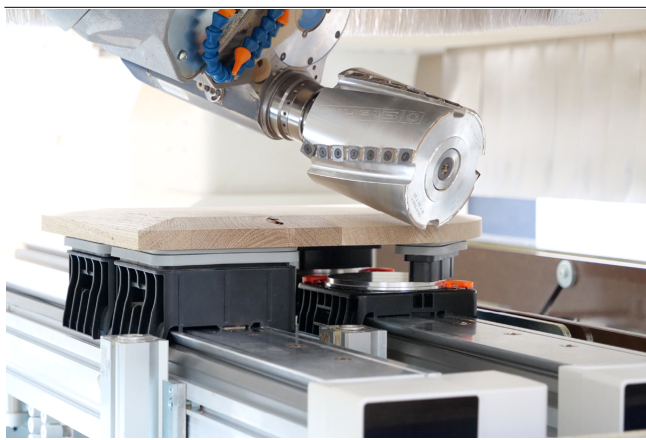

Vacuum block VCBL-S6 used with SCM consoles

Suitability for industry specific applications

Applications

- Modular system for use on SCM and Morbidelli console tables, compatible with the original equipment
- Available in various dimensions and working heights with accessories for a wide range of woodworking applications
- Safe clamping of demanding workpieces with curved contours or rough surfaces
- Can also be used for Flexmatic machine tables with automatic positioning and Start/Pilot with position detection thanks to the trip dog and magnet accessories

Design

- Suction plate with membrane (1) made of elastomer for optimum sealing behaviour, high friction forces and protection against penetrating chips
- Integrated NFC tag (2) for reading out product data via smartphone
- Easy-action touch valve (3) for automatic activation of the vacuum
- Suction cup (4) can be inserted into the mounting in 15° steps and fixed by turning the clamping levers (5)
- Robust main body (6) made of glass-fibre reinforced plastic with dovetail mount for fixing on SCM/Morbidelli consoles
- Durable sealing frame (7) optimized for effortless sliding of the suction cup on the console

Product highlights

- Proven clamping concept guarantees highest holding forces and precision for optimum efficiency and quality in the production process
- Range of flexible suction cups and accessories enables a wide range of applications in woodworking
- Shorter set-up times and reduced spare parts costs due to pluggable suction cups, tool-free fixing and simple spare parts exchange
- Replaceable suction plate with membrane prevents penetration of dirt and ensures constant performance
- Integrated NFC tag for quick readout of product data and matching spare parts

Vacuum Blocks VCBL-S6

For TV systems from SCM · Height 50 mm, 75 mm and 110 mm

Designation code Vacuum Blocks VCBL-S6

VCBL-S6	-	120x50	-	x50	-	S-360-15	-	TV
1		2		3		4		5

1 – Abbreviated designation

Code	Type
VCBL-S6	Vacuum block, SCM/Morbidelli TV system
VCBL-S6-CUP	Suction cup, SCM/Morbidelli TV system

2 – Suction area

Code	LxW in mm
145x145...	145x145 to 130x30
130x30	

3 – Height

Code	LxW in mm
x25...x110	25 to 110

4 – Product addition

Code	Type
S-360-15	Rotatable in 15° steps

5 – Product addition

Code	Type
TV	With sensing valve
TV+ME	With sensing valve and membrane

Vacuum blocks with a suction area of 145 x 145 mm are delivered assembled.













Narrow vacuum blocks with suction area 125 x 75 mm, 120 x 50 mm and 130 x 30 mm consist of several parts:

- Mounting AP-S6 incl. foam sealing frame and O-ring
- Suction cup incl. suction plate, touch valve and NFC tag
- Mounting and suction cup are available separately

Available spare parts: suction plate VCSP-O, foam sealing frame VCDR, touch valve TV, suction cup VCBL-S6-CUP, mounting AP-S6

Available accessories: suction plate foam rubber, switching cams for position detection, magnet for position detection

Ordering data Vacuum Blocks VCBL-S6

Type				Dimensions (LxW):			
				145x145	125x75	120x50	130x30
VCBL-S6	50	-	TV+ME	10.01.12.04460 	-	-	-
VCBL-S6	50	S-360-15	TV+ME	-	10.01.12.04461 	-	-
VCBL-S6	50	S-360-15	TV	-	-	10.01.12.04462 	10.01.12.04463 
VCBL-S6	75	-	TV+ME	10.01.12.04456 	-	-	-
VCBL-S6	75	S-360-15	TV+ME	-	10.01.12.04457 	-	-
VCBL-S6	75	S-360-15	TV	-	-	10.01.12.04458 	10.01.12.04459 
VCBL-S6	110	-	TV+ME	10.01.12.04452 	-	-	-
VCBL-S6	110	S-360-15	TV+ME	-	10.01.12.04453 	-	-
VCBL-S6	110	S-360-15	TV	-	-	10.01.12.04454 	10.01.12.04455 

Type				Dimensions (LxW):		
				125x75	120x50	130x30
VCBL-S6	CUP	25	TV+ME	10.01.12.04638	-	-
VCBL-S6	CUP	25	TV	-	10.01.12.04639	10.01.12.04654
VCBL-S6	CUP	50	TV+ME	10.01.12.04628	-	-
VCBL-S6	CUP	50	TV	-	10.01.12.04629	10.01.12.04630
VCBL-S6	CUP	85	TV+ME	10.01.12.04625	-	-
VCBL-S6	CUP	85	TV	-	10.01.12.04626	10.01.12.04627

Type	Part no.
AP-S6-145x145x25	10.01.12.04440 

Vacuum Blocks VCBL-S6

For TV systems from SCM · Height 50 mm, 75 mm and 110 mm

Ordering data Spare parts Vacuum Blocks VCBL-S6

Type	Spare parts			Part no.
VCBL-S6	145x145	Suction plate (top)	VCSP-O 145x145x16.5 ME	10.01.12.04445
VCBL-S6	125x75	Suction plate (top)	VCSP-O 125x75x16.5 ME	10.01.12.04766
VCBL-S6	120x50	Suction plate (top)	VCSP-O 120x50x15.5	10.01.12.00012
VCBL-S6	130x30	Set of spare parts	ERS VCSP	10.01.12.01543

Type	Spare parts		Part no.
VCBL-S6	Sealing frame (bottom)	VCDR 135x25.5x6 VCBL	10.01.12.04560

Type	Spare parts		Part no.
VCBL-S6	Touch Valve	TV D9 4.3	10.01.12.02514

Ordering data Accessories Vacuum Blocks VCBL-S6

Type	Accessories			Part no.	
VCBL-S6	145x145	Suction plate (top)	Foam rubber suction plate	VCSP-O 145x145x17.9 ME-MOS	10.01.12.04818
VCBL-S6	125x75	Suction plate (top)	Foam rubber suction plate	VCSP-O 125x75x17.9 ME-MOS	10.01.12.04836

Type	Accessories		Part no.	
VCBL-S6	Switching cam	Trip cams for Flexmatic machine tables	SCHA-NOCK 12x7.6x20 VCBL-S6	10.01.12.04741

Type	Accessories		Part no.	
VCBL-S6	Accessories-clamping systems	Magnet for launch and pilot machine tables	ZUB VCBL-S6	10.01.12.04841

Vacuum Blocks VCBL-S6

For TV systems from SCM · Height 50 mm, 75 mm and 110 mm

Design data Vacuum Blocks VCBL-S6

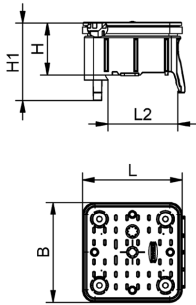

VCBL-S6

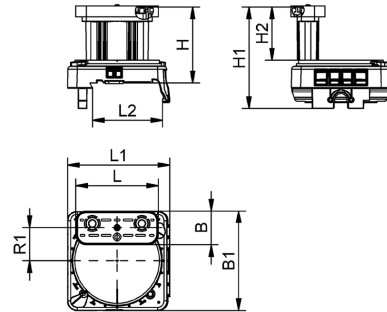

VCBL-S6 D-360

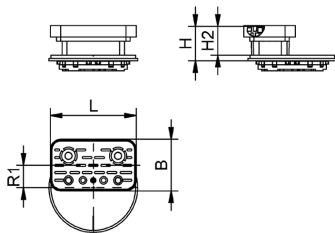

VCBL-S6-CUP

Vacuum Blocks VCBL-S6

For TV systems from SCM · Height 50 mm, 75 mm and 110 mm

Design data Vacuum Blocks VCBL-S6

Type	B [mm]	H [mm]	H1 [mm]	L [mm]	L2 [mm]
VCBL-S6 145x145x50 TV+ME	145	50	88	145.0	104
VCBL-S6 145x145x75 TV+ME	145	75	113	145.0	104
VCBL-S6 145x145x110 TV+ME	145	110	148	145.0	104

Type	B [mm]	B1 [mm]	H [mm]	H1 [mm]	H2 [mm]	L [mm]	L1 [mm]	L2 [mm]	R1 [mm]
VCBL-S6 125x75x50 S-360-15 TV+ME	75	144	50	88	17.0	125.0	149	104	33
VCBL-S6 120x50x50 S-360-15 TV	50	144	50	88	17.0	120.0	149	104	48
VCBL-S6 130x30x50 S-360-15 TV	30	144	50	88	17.0	130.0	149	104	55
VCBL-S6 125x75x75 S-360-15 TV+ME	75	144	75	113	42.0	125.0	149	104	33
VCBL-S6 120x50x75 S-360-15 TV	50	144	75	113	42.0	120.0	149	104	48
VCBL-S6 130x30x75 S-360-15 TV	30	144	75	113	42.0	130.0	149	104	55
VCBL-S6 125x75x110 S-360-15 TV+ME	75	144	110	148	77.0	125.0	149	104	33
VCBL-S6 120x50x110 S-360-15 TV	50	144	110	148	77.0	120.0	149	104	48
VCBL-S6 130x30x110 S-360-15 TV	30	144	110	148	77.0	130.0	149	104	55

Type	B [mm]	H [mm]	H2 [mm]	L [mm]	R1 [mm]
VCBL-S6-CUP 125x75x25 TV+ME	75	25	17.0	125.0	33
VCBL-S6-CUP 120x50x25 TV	50	25	17.0	120.0	48
VCBL-S6-CUP 130x30x25 TV	30	25	17.0	130.0	55
VCBL-S6-CUP 125x75x50 TV+ME	75	50	42.0	125.0	33
VCBL-S6-CUP 120x50x50 TV	50	50	42.0	120.0	48
VCBL-S6-CUP 130x30x50 TV	30	50	42.0	130.0	55
VCBL-S6-CUP 125x75x85 TV+ME	75	85	77.0	125.0	33
VCBL-S6-CUP 120x50x85 TV	50	85	77.0	120.0	48
VCBL-S6-CUP 130x30x85 TV	30	85	77.0	130.0	55

Multimedia product presentation

Medium	Link
Product video	https://vimeo.com/568894474 https://vimeo.com/567413631